

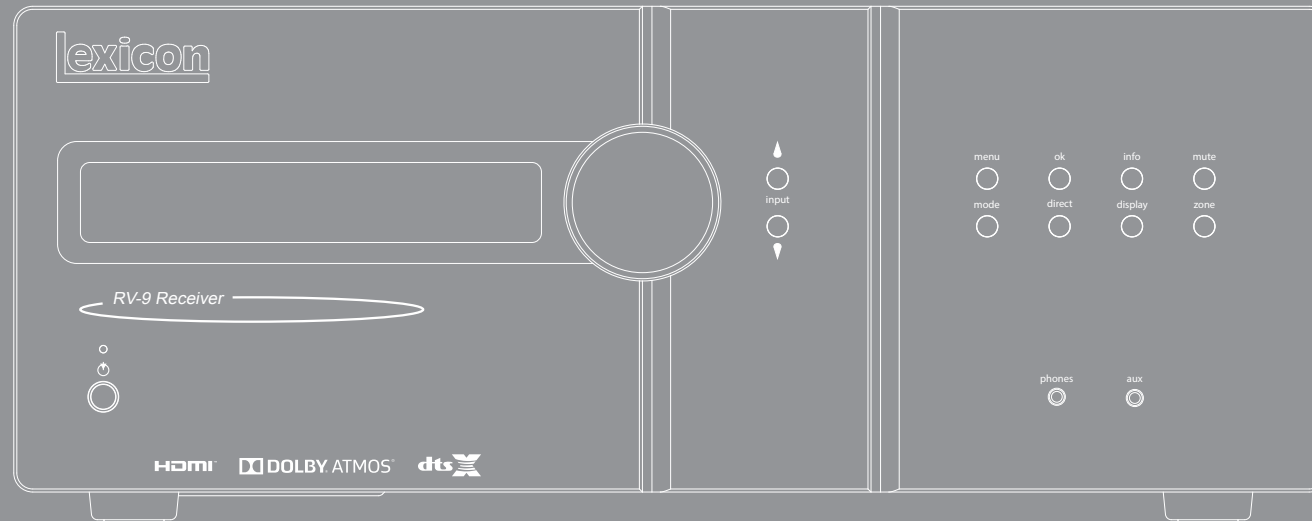

English

RV-6, RV-9, MC-10

Owners Manual



safety

Important safety instructions

1. Read these instructions.
2. Keep these instructions.
3. Heed all warnings.
4. Follow all instructions.
5. Do not use this apparatus near water.
6. Clean only with a dry cloth.

Unplug the unit from the mains supply before cleaning. The case should normally only require a wipe with a soft, lint-free cloth. Do not use chemical solvents for cleaning. We do not advise the use of furniture cleaning sprays or polishes as they can cause permanent white marks.

7. Do not block any of the ventilation openings.

Install in accordance with the manufacturer's instructions.

8. Do not install near any heat sources such as radiators, heat registers, stoves, or other apparatus (including amplifiers) that produce heat.

9. Do not defeat the safety purpose of the polarized or grounding type plug.

A polarized plug has two blades with one wider than the other. A grounding type plug has two blades and a third grounding prong. The wide blade or the third prong is provided for your safety. When the provided plug does not fit into your outlet, consult an electrician for replacement of the obsolete outlet.

10. Protect the power cord from being walked on or pinched particularly at plugs, convenient receptacles, and the point where they exit from the apparatus.

11. Only use the attachments/accessories specified by the manufacturer.

12. Use only with a cart, stand, tripod, bracket, or table specified by the manufacturer, or sold with the apparatus.

When a cart is used, use caution when moving the cart/apparatus combination to avoid injury from tip-over.



13. Unplug this apparatus during lightning storms or when unused for long periods of time.

14. Refer all servicing to qualified service personnel.

Service is required when the apparatus has been damaged in any way, such as power supply cord or plug is damaged, liquid has been spilled or objects have fallen into the apparatus, the apparatus has been exposed to rain or moisture, does not operate normally, or has been dropped.

15. Object or liquid entry

WARNING – Take care that objects do not fall and liquids are not spilled into the enclosure through any openings. The equipment shall not be exposed to dripping or splashing. Liquid-filled objects such as vases should not be placed on the equipment.

16. Service Instructions

CAUTION – These servicing instructions are for use by qualified service personnel only. To reduce the risk of electric shock, do not perform any servicing other than

that contained in the operating instructions unless you are qualified to do so.

17. Climate

The equipment has been designed for use in moderate climates and in domestic situations. Unplug this equipment during lightning storms to prevent possible damage from a strike or mains surge.

18. Power sources

Only connect the equipment to a power supply of the type described in the operating instructions or as marked on the equipment.

The primary method of isolating the equipment from the mains supply is to remove the mains plug. The equipment must be installed in a manner that makes disconnection possible.

19. Power-cord protection

Power supply cords should be routed so that they are not likely to be walked on or pinched by items placed upon or against them. Pay particular attention to the point where they exit from the equipment.

20. Power lines

Locate any outdoor antenna/aerial away from power lines.

21. Speaker connections

Any speakers must be connected to the Receiver using class II wire (i.e. no connection to Earth should be made). Failure to observe this precaution may cause the unit to become damaged.



CAUTION: To reduce the risk of electric shock, do not remove cover (or back). No user serviceable parts inside. Refer servicing to qualified service personnel.

WARNING: To reduce the risk of fire or electric shock, do not expose this apparatus to rain or moisture.



The lightning flash with an arrowhead symbol, within an equilateral triangle, is intended to alert the user to the presence of uninsulated 'dangerous voltage' within the product's enclosure that may be of sufficient magnitude to constitute a risk of electric shock to persons.



The exclamation point within an equilateral triangle is intended to alert the user to the presence of important operating and maintenance (servicing) instructions in the literature accompanying the appliance.

CAUTION: In Canada and the USA, to prevent electric shock, match the wide blade of the plug to the wide slot in the socket and insert the plug fully into the socket.

Class II product



This equipment is a Class II or double insulated electrical appliance. It has been designed in such a way that it does not require a safety connection to electrical earth ('ground' in the U.S.).

22. Non-use periods

If the equipment is not being used for an extended period, we recommend that you unplug the power cord of the equipment from the outlet, to save power.

23. Abnormal smell

If an abnormal smell or smoke is detected from the equipment, turn the power off immediately and unplug the equipment from the wall outlet. Contact your dealer and do not reconnect the equipment.

CAUTIONS ON INSTALLATION

For proper heat dispersal, do not install this unit in a confined space, such as a bookcase or similar enclosure.

- More than 0.3 m (12 in.) is recommended.
- Do not place any other equipment on this unit.

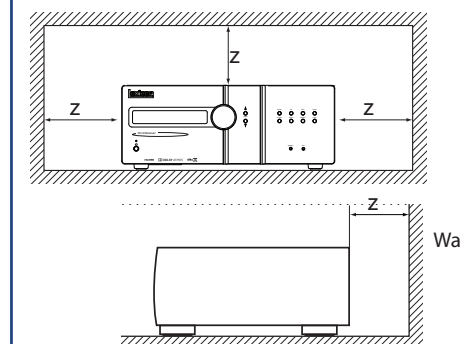

FCC INFORMATION (FOR US CUSTOMERS)**1. PRODUCT**

This product complies with Part 15 of the FCC Rules. Operation is subject to the following two conditions:

(1) This device may not cause harmful interference, and (2) this device must accept any interference received, including interference that may cause undesired operation.

2. IMPORTANT NOTICE:**DO NOT MODIFY THIS PRODUCT**

This product, when installed as indicated in the instructions contained in this manual, meets FCC requirements. Modification not expressly approved by ARCAM may void your authority, granted by the FCC, to use the product.

3. NOTE

This product has been tested and found to comply with the limits for a Class B digital device, pursuant to Part 15 of the FCC Rules. These limits are designed to provide reasonable protection against harmful interference in a residential installation.

This product generates, uses and can radiate radio frequency energy and, if not installed and used in accordance with the instructions, may cause harmful interference to radio communications. However, there is no guarantee that interference will not occur in a particular installation. If this product does cause harmful interference to radio or television reception, which can be determined by turning the product OFF and ON, the user is encouraged to try to correct the interference by one or more of the following measures:

- Reorient or relocate the receiving antenna.
- Increase the separation between the equipment and receiver.
- Connect the product into an outlet on a circuit different from that to which the receiver is connected.
- Consult the local retailer authorized to distribute this type of product or an experienced radio/TV technician for help.

**SAFETY INFORMATION
(FOR EUROPEAN CUSTOMERS)**

- Avoid high temperatures. Allow for sufficient heat dispersion when installed in a rack.
- Handle the power cord carefully. Hold the plug when unplugging the cord.
- Keep the unit free from moisture, water, and dust.
- Unplug the power cord when not using the unit for long periods of time.
- Do not obstruct the ventilation holes.
- Do not let foreign objects into the unit.
- Do not let insecticides, benzene, and thinner come in contact with the unit.
- Never disassemble or modify the unit in any way.
- Ventilation should not be impeded by covering the ventilation openings with items, such as newspapers, tablecloths or curtains.

- Naked flame sources such as lighted candles should not be placed on the unit.
- Observe and follow local regulations regarding battery disposal.
- Do not expose the unit to dripping or splashing fluids.
- Do not place objects filled with liquids, such as vases, on the unit.
- Do not handle the mains cord with wet hands.
- When the switch is in the OFF position, the equipment is not completely switched off from MAINS.
- The equipment shall be installed near the power supply so that the power supply is easily accessible.

A NOTE ABOUT RECYCLING:

This product's packaging materials are recyclable and can be reused. Please dispose of any materials in accordance with the local recycling regulations. When discarding the unit, comply with local rules or regulations.

Batteries should never be thrown away or incinerated but disposed of in accordance with the local regulations concerning battery disposal.

This product and the supplied accessories, excluding the batteries, constitute the applicable product according to the WEEE directive.

CORRECT DISPOSAL OF THIS PRODUCT

These markings indicate that this product should not be disposed with other household waste throughout the EU.

To prevent possible harm to the environment or human health from uncontrolled waste disposal and to conserve material resources, this product should be recycled responsibly.

To dispose of your product, please use your local return and collection systems or contact the retailer where the product was purchased.



Contents

safety	E-2
welcome.....	E-5
before you begin... ..	E-6
rear panel connectors	E-9
audio/video connections	E-10
Connection guide	E-12
radio connectors	E-13
other connectors.....	E-14
speakers.....	E-15
operation.....	E-17
front panel operation.....	E-19
remote control.....	E-20
essential setup.....	E-26
auto speaker setup.....	E-27
setup menus	E-28
decoding modes	E-32
Dolby volume	E-34
Dolby atmos.....	E-34
tuner operation.....	E-35
network/usb operation	E-36
multi-room set up.....	E-37
customising the remote	E-38
troubleshooting.....	E-40
specifications.....	E-42
legal information	E-47
product guarantee	E-47

Thank you for choosing Lexicon to enhance the performance of your Home Cinema.

The Lexicon RV-6 and RV-9 Immersive Surround Sound AV receivers and the MC-10 pre amp/processor are designed to bring outstanding audio and video quality into your private cinema. With Dolby ATMOS & DTS:X 3D surround sound processing, as well as traditional surround decoding, a truly immersive experience is delivered. An audiophile grade 24Bit /192kHz DAC, Dirac room equalization and low distortion ensure premium surround sound for music and movies. The Harman proprietary Logic7 Immersion™ up mixer allows stereo sources to envelop the listener with a rich and natural three dimensional sound. The RV-6 and RV-9 feature pristine power, exceptional dynamics and low distortion; even when all channels are driven. All three models offer flexible configuration, Spotify Connect, and a zone 2 with audio, 4K video, IR control and triggers; making these products an excellent choice for a broad range of applications.

Please review this owner's manual, as it contains vital information on set up, configuration, and operation. It should be kept for future reference. Please visit www.lexicon.com for the latest information on these products.

welcome

English

Professional Installation?

It may be that the Receiver has been installed and set up as part of your Hi-Fi installation by a qualified Lexicon dealer. In this case, you may wish to skip the sections of this handbook dealing with installation and setting up, and move directly to the sections dealing with using the unit. Use the Contents list to guide you to these sections.

DIY setup?

The Receiver is a powerful and sophisticated piece of AV equipment. If you are setting the unit up yourself, it is recommended that you read this handbook thoroughly before beginning. For instance, correct speaker configuration and placement is a key to getting the most out of your Receiver and making sure that all the elements of your system work in harmony.

before you
begin...

The Lexicon RV-6 and RV-9 AV receivers and the MC-10 home cinema processor (henceforth "receiver") are high-quality and high-performance home-cinema processors and amplifiers built to Lexicon's quality design and manufacturing standards. They combine digital processing with high-performance audio and video components to bring you an unrivalled home-entertainment center.

The Receiver allows switching and control of seven analog and six digital audio sources in addition to internal FM and DAB radios – as well as networked and USB audio sources – making any of the models an ideal hub for both home-cinema and two-channel stereo systems.

Since many of these source components are also capable of generating video signals, the Receiver includes

broadcast-quality switching for HDMI (6 x HDMI2.0a, HDCP2.2 & 1 x MHL) video/audio signals. Control of the Receiver is either by front panel control buttons, IR remote control, IP (Ethernet) control or RS232 port.

The remote control supplied with the Receiver is a multi-device 'universal' learning remote control which is simple to use, and once set up is able to control a complete system. It can be programmed using its vast internal code library to control CD and BD players, PVRs, TVs and other devices.

The installation of the Receiver in a listening room is an important process which requires care at every stage. For this reason, the installation information is very comprehensive and should be followed carefully to achieve an unrivalled level of performance.

The Receiver designed to produce a level of performance that will truly bring music and movies to life.

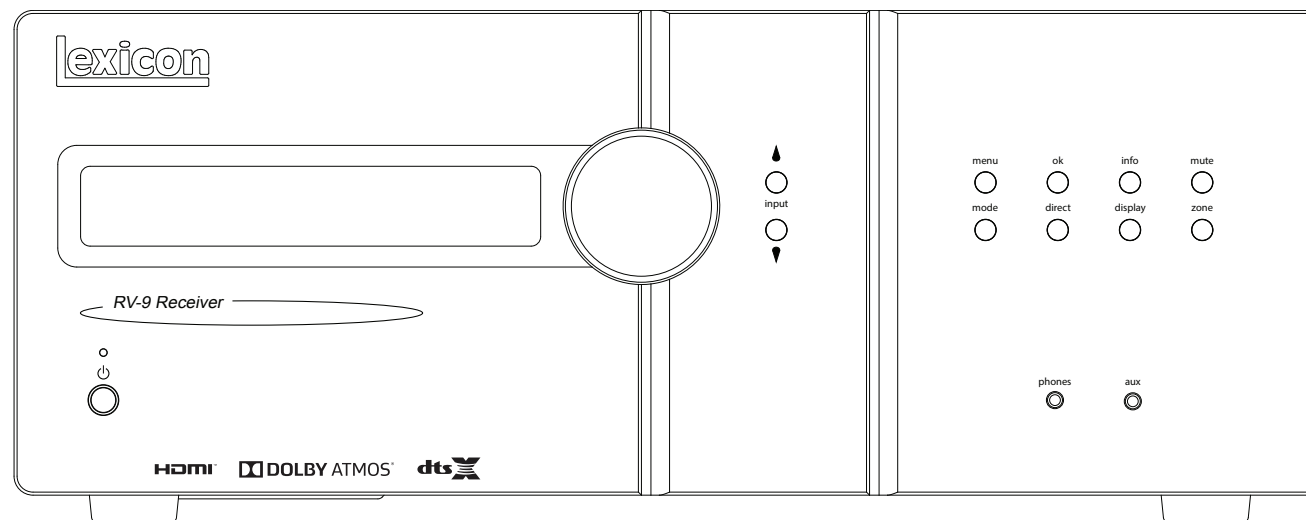

Placing the unit

- Place the unit on a level, firm surface, avoiding direct sunlight and sources of heat or damp.
- Do not place the Receiver on top of a power amplifier or other source of heat.
- Do not place the amplifier in an enclosed space such as a bookcase or closed cabinet unless there is good provision for ventilation. The Receiver will run warm during normal operation.
- Do not place any other component or item on top of the amplifier as this may obstruct airflow around the heat-sink, causing the amplifier to run hot. (The unit placed on top of the amplifier would become hot, too.)
- Make sure the remote-control receiver on the front panel display is unobstructed, otherwise this will impair the use of the remote-control. If line-of-sight is impractical, a remote-control repeater can be used with the rear panel connector (see page E-14).
- Do not place your turntable on top of this unit. Turntables are very sensitive to the noise generated by mains power supplies which will be heard as a background 'hum' if the turntable is too close.

Power

The amplifier is supplied with a moulded mains plug already fitted to the lead. Check that the plug supplied fits your supply – should you require a new mains lead, please contact your Lexicon dealer.

If your mains supply voltage or mains plug is different, please contact your Lexicon dealer immediately.

The Receiver can be switched for operation between 220–240V (switch position 230V) and 110–120V (switch position 115V).

NOTE

Ensure that the Receiver is switched off and the power lead removed before changing the position of the voltage range switch.

Push the IEC plug end of the power cable into the socket on the back of the amplifier, making sure that it is pushed in firmly. Plug the other end of the cable into your mains socket and, if necessary, switch the socket on.

The Receiver can be turned on using the **POWER** switch on the front panel. While switched on, the front panel LED will glow green.

Standby power

The Receiver can be switched into standby mode using the  button on the remote control. While in standby mode the front panel LED will glow red and power consumption is less than 0.5 Watts.

While in Standby mode, it may be possible to hear a slight residual hum coming from the mains transformer inside the amplifier. This is perfectly normal. However, if the unit is to be left unused for an extended period, we recommend that you disconnect it from the mains supply to save power.

Interconnect cables

We recommend the use of high-quality shielded cables that are designed for the particular application. Other cables will have different impedance characteristics that will degrade the performance of your system (for example, do not use cabling intended for video use to carry audio signals). All cables should be kept as short as is practically possible.

It is good practice when connecting your equipment to make sure that the mains power-supply cabling is kept as far away as possible from your audio cables. Failure to do so may result in unwanted noise in the audio signals.

For information on speaker cabling, please refer to the 'Speakers' section, beginning on page E-15.

Radio interference

The Receiver is an audio device containing microprocessors and other digital electronics. Each model has been designed to very high standards of electromagnetic compatibility.

This is a Class A product. In a domestic environment this product may cause radio interference, in which case the user may be required to take adequate measures.









If the Receiver causes interference to radio or television reception (which can be determined by switching the Receiver off and on), the following measures should be taken:

- Re-orient the receiving antenna or route the antenna cable of the affected receiver as far as possible from Receiver and its cabling.
- Relocate the receiver with respect to the Receiver.
- Connect the affected device and the Receiver to different mains outlets.



If the problem persists, please contact your Lexicon dealer.

Trademark acknowledgements

Lexicon is a registered trademark of Harman International Industries, Inc.

	Dolby Volume Manufactured under license from Dolby Laboratories. Dolby and the double-D symbol are trademarks of Dolby Laboratories.
  	Dolby Atmos, Dolby Audio Manufactured under license from Dolby Laboratories. Dolby, Dolby Atmos, Dolby Audio, and the double-D symbol are registered trademarks of Dolby Laboratories.
	DTS-HD Master Audio™ For DTS patents, see http://patents.dts.com . Manufactured under license from DTS Licensing Limited. DTS, the Symbol, & DTS together in combination with the Symbol are trademarks of DTS, Inc. DTS and DTS-HD Master Audio are registered trademarks of DTS, Inc. © DTS, Inc. All Rights Reserved.
	DTS-HD™ For DTS patents, see http://patents.dts.com . Manufactured under license from DTS Licensing Limited. DTS, DTS-HD, the Symbol, & DTS and the Symbol together are registered trademarks of DTS, Inc. © DTS, Inc. All Rights Reserved.
	DTS:X® For DTS patents, see http://patents.dts.com . Manufactured under license from DTS Licensing Limited. DTS, the Symbol, DTS in combination with the symbol, DTS:X and the DTS:X logo are registered trademarks or trademarks of DTS, Inc. in the United States and/or other countries. © DTS, Inc. All Rights Reserved.
	DTS Virtual:X™ For DTS patents, see http://patents.dts.com . Manufactured under license from DTS Licensing Limited. DTS, the Symbol, DTS and the symbol together, Virtual:X and the DTS Virtual:X logo are registered trademarks and/or trademarks of DTS, Inc. in the United States and/or other countries. © DTS, Inc. All Rights Reserved.
	IMAX® & DTS® Manufactured under license from IMAX Corporation. IMAX® is a registered trademark of IMAX Corporation in the United States and/or other countries. For DTS patents, see http://patents.dts.com . Manufactured under license from DTS Licensing Limited. DTS, the Symbol, DTS and the symbol together are registered trademarks or trademarks of DTS, Inc. in the United States and/or other countries. © DTS, Inc. All Rights Reserved.

FLAC	FLAC Decoder Copyright © 2000, 2001, 2002, 2003, 2004, 2005, 2006, 2007, 2008 Josh Coalson Redistribution and use in source and binary forms, with or without modification, are permitted provided that the following conditions are met: - Redistributions of source code must retain the above copyright notice, this list of conditions and the following disclaimer. - Redistributions in binary form must reproduce the above copyright notice, this list of conditions and the following disclaimer in the documentation and/or other materials provided with the distribution. - Neither the name of the Xiph.org Foundation nor the names of its contributors may be used to endorse or promote products derived from this software without specific prior written permission. THIS SOFTWARE IS PROVIDED BY THE COPYRIGHT HOLDERS AND CONTRIBUTORS 'AS IS' AND ANY EXPRESS OR IMPLIED WARRANTIES, INCLUDING, BUT NOT LIMITED TO, THE IMPLIED WARRANTIES OF MERCHANTABILITY AND FITNESS FOR A PARTICULAR PURPOSE ARE DISCLAIMED. IN NO EVENT SHALL THE FOUNDATION OR CONTRIBUTORS BE LIABLE FOR ANY DIRECT, INDIRECT, INCIDENTAL, SPECIAL, EXEMPLARY, OR CONSEQUENTIAL DAMAGES (INCLUDING, BUT NOT LIMITED TO, PROCUREMENT OF SUBSTITUTE GOODS OR SERVICES; LOSS OF USE, DATA, OR PROFITS; OR BUSINESS INTERRUPTION) HOWEVER CAUSED AND ON ANY THEORY OF LIABILITY, WHETHER IN CONTRACT, STRICT LIABILITY, OR TORT (INCLUDING NEGLIGENCE OR OTHERWISE) ARISING IN ANY WAY OUT OF THE USE OF THIS SOFTWARE, EVEN IF ADVISED OF THE POSSIBILITY OF SUCH DAMAGE.
-------------	---

	AAC/AAC Plus aacPlus is a trademark of Coding Technologies. See http://codtech.vhost.noris.net for more information.
	HDMI, the HDMI logo and High-Definition Multimedia Interface are trademarks or registered trademarks of HDMI Licensing LLC.
	Licenses: The Spotify software is subject to third party licenses found here: https://developer.spotify.com/esdk-third-party-licenses
vTuner	This product is protected by certain intellectual property rights of NEMS and BridgeCo. Use or distribution of such technology outside of this product is prohibited without a license from NEMS and BridgeCo or an authorized subsidiary.
MP3	MPEG Layer-3 audio decoding technology licensed from Fraunhofer IIS and Thomson multimedia.

rear panel connectors

NOTE
Please read the 'Placing the unit', 'Power' and 'Interconnect cables' sections on page E-7 before connecting up your Receiver!

English

RV-9
RV-6

Audio connectors
Analog two-channel, see page E-11.

Preamplifier output
see page E-11.

HDMI connectors
For information, see page E-10.

Digital connectors
Coaxial and optical digital audio connectors, see page E-11.

FM/DAB
FM aerial socket, or DAB aerial socket.

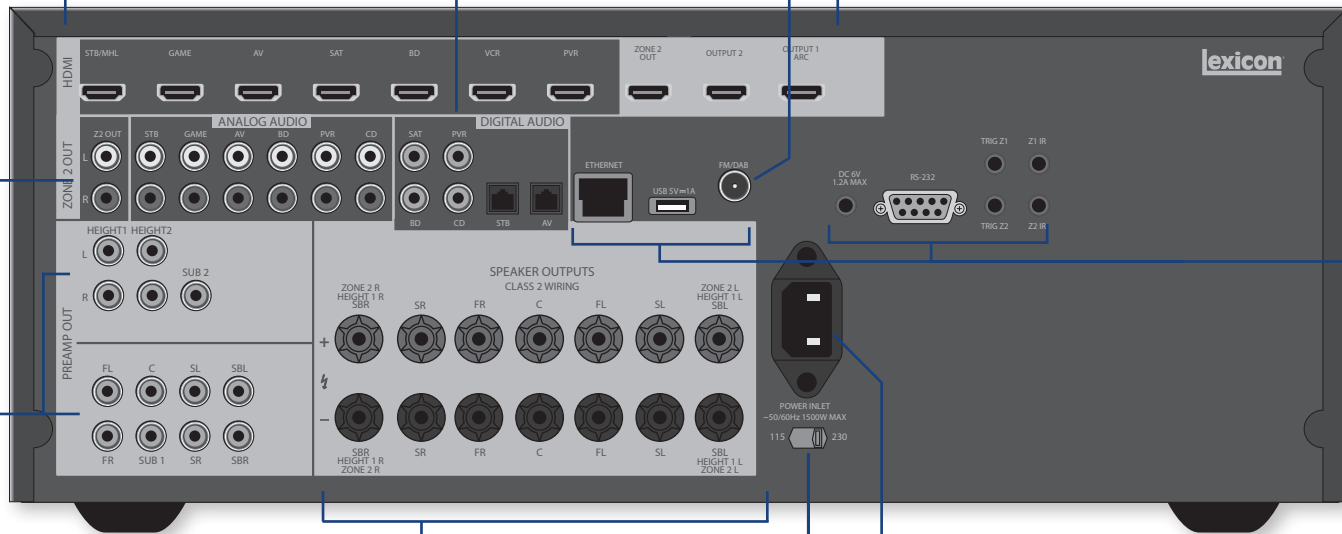

Aerials, control and communication
Network, USB, FM/DAB aerial, voltage output, serial control, trigger and IR connectors, see page E-13, E-14.

Speaker connectors
For information, see page E-16.

Power inlet
Connect the correct mains cable here

Voltage select
Ensure the voltage selected matches your local power supply.

MC-10

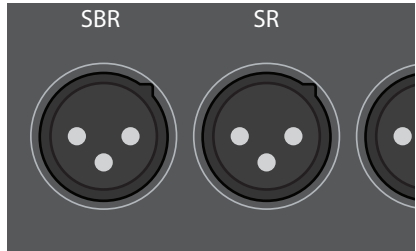

audio/video connections

Before connecting your Receiver to your source components and speakers, please read through the next few pages which will explain all the input and output connectivity that is available. The 'Speakers' section explains how to connect up your speakers to avoid damage to the amplifier and how to arrange your speakers for best performance.

General

The inputs are named to make it easier to reference connected devices (e.g. 'BD' or 'VCR'). They all have the same input circuit, so there is no reason why you should not connect a different device to any of the inputs. For example, if you had two BD players and the AV input was not being used, then the second BD player could be connected to the AV input.

When connecting a video source, its audio must be connected to the corresponding sockets. For example, if you had a satellite decoder plugged into a **SAT** video input, the audio must be connected to the **SAT** audio inputs!

Making connections

- Take care to place cables as far from any power supply cabling as is practicable, to reduce hum and other noise problems.

NOTE:

For each input, you must set the '**Video Source**' and '**Audio Source**' settings according to the connection type. (see "Input Config." on page E-29)



HDMI connectors

STB, GAME, AV, SAT, BD, VCR, PVR

Connect the HDMI video outputs of your source equipment to these corresponding HDMI inputs.

OUTPUT

Connect this output to the HDMI video input of your display device. This output is compatible with HDMI Audio Return Channel (ARC). If you have a supported television then sound from the television's internal tuner (e.g. Freeview, Freesat, DVB-T) will be available using the Receiver's 'Display' input.

Digital audio connectors



SAT, PVR, BD, CD, STB, AV

Connect these inputs to the digital outputs of your available source equipment.

Zone 2 connectors

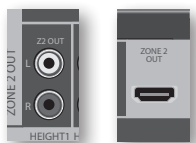

The Z2 out HDMI connector can be used to connect the output of the Receiver to a system located in a second room.

Analog preamplifier outputs

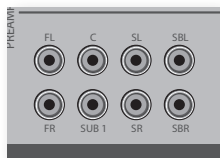

All preamplifier analog outputs are buffered, have a low output impedance, are at line level and follow the Zone 1 volume control setting. They are able to drive long cables or several inputs in parallel if required.

For more information on connecting speakers or additional power amplifiers, see page E-15 and E-16.

The MC-10 has XLR outputs in addition to the phono pre-outs for connection to an external amplifier.

Analog audio inputs



STB, GAME, AV, BD, PVR, CD

Connect the left and right inputs to the left and right outputs of your source equipment.

Front panel AUX input

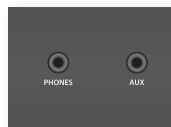

The front panel **AUX** input can be used as an analog input, using a stereo 3.5mm lead.

Front panel PHONES socket

This socket accepts headphones with an impedance rating between 32Ω and 600Ω, fitted with a 3.5mm stereo plug. The headphone socket is always active, except when Receiver is muted.

When the headphone plug is inserted, the speaker outputs and analog preamplifier outputs are automatically muted.

Connection guide

Blu-ray Disc (BD)/DVD player

The diagram shows how to make audio and video connections from a typical BD/DVD player.

The preferred audio hook-up is using the HDMI or coaxial digital connector (usually marked **DIGITAL AUDIO OUT**), in addition to the coaxial analog outputs for left and right channels.

In each case, use the audio inputs labelled **BD** on the Receiver.

Satellite receiver

A satellite receiver is connected in the same way as a BD player, with the same order of preference according to the outputs provided by the satellite receiver.

In each case, use the inputs labelled **SAT** on the Receiver. Note that digital audio input from a satellite receiver sometimes requires a coaxial/TOSLINK (digital connector) interconnect cable, as some satellite receivers do not implement audio over HDMI properly or at all.

CD player

Connect the digital audio output (if provided by the CD player) to the digital **CD** input of the Receiver, using a high quality coaxial interconnect cable.

Connect the right and left analog audio outputs of the CD player to the analog **CD** inputs of the Receiver, using a pair of high quality coaxial interconnect cables.

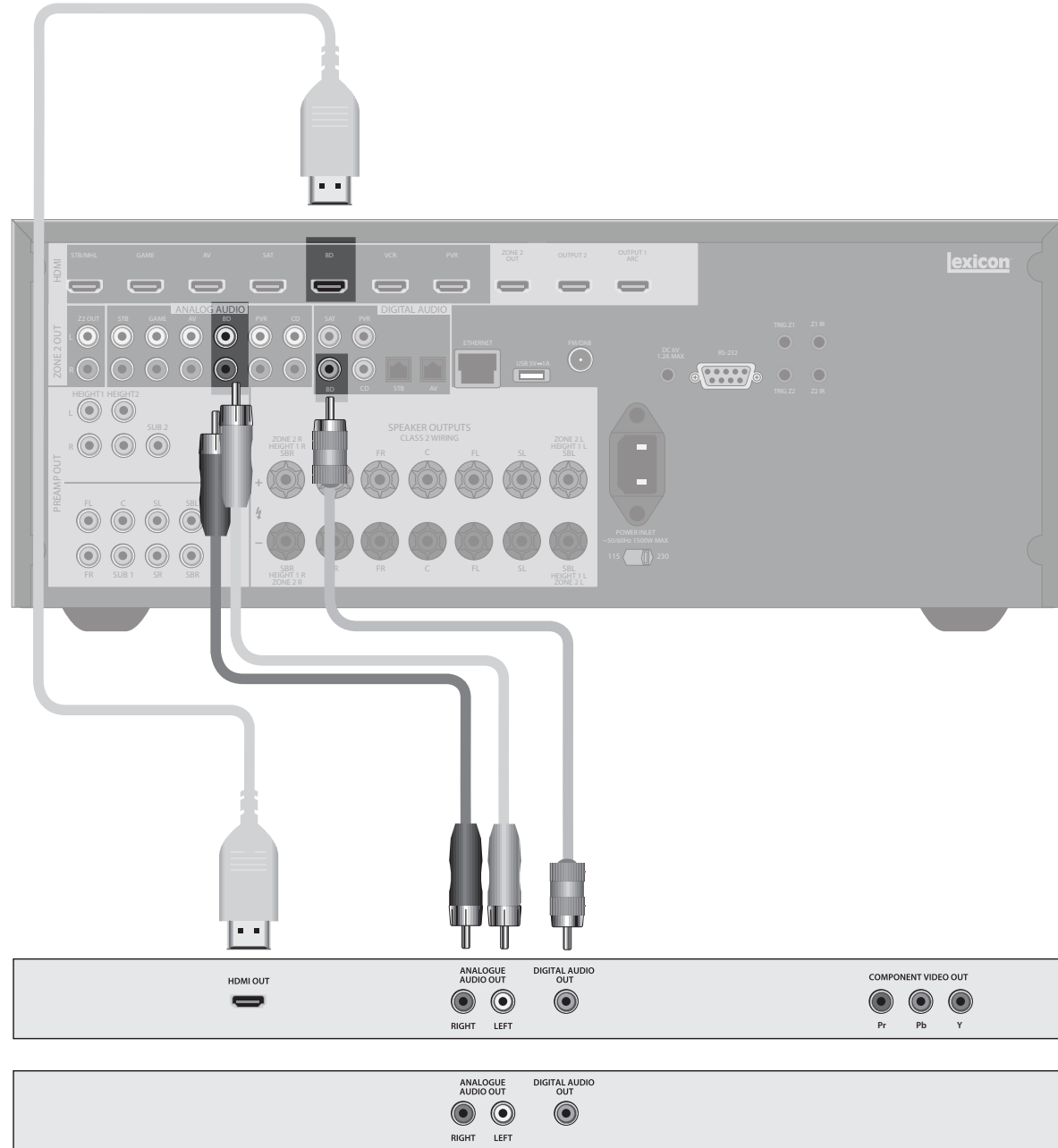

NOTE:
For each input, you must set the **'Audio Source'** setting according to the connection type. (see "Input Config." on page E-29)

radio connectors

Aerial connectors

The Receiver is fitted with an FM and a DAB/DAB+ receiver module. The type of aerial you need depends on your listening preferences and the local conditions.

Your Receiver is capable of superb radio reception, but only if it is receiving a good quality transmission signal.

Try the aerials supplied with your unit. If you are in a medium to strong signal area, these should be adequate for good reception. In areas with poor signal strength, you may require a roof or loft mounted aerial.

Contact your local Lexicon dealer or aerial installation experts for advice about local reception conditions.

DAB/FM



In strong signal areas, the DAB/FM 'T' wire aerial supplied can be used with reasonable results. Mount the aerial as high up as possible on a wall.



In the UK the 'T'-elements need to be positioned vertically for DAB reception since broadcasts are vertically polarised. In other localities, check with your Lexicon dealer or try both horizontal and vertical positions for best reception.

Try each usable wall of the room to see which gives best reception and use tacks or adhesive tape to secure the aerial in a 'T' shape, but note that no tacks should come into contact with the internal wire of the aerial.

When installed and receiving DAB/FM, check the signal strength by pressing the front panel or remote control's **INFO** button until the signal quality indicator is displayed.

In weak signal areas, a high-gain, externally-mounted or roof-mounted aerial is desirable in order to receive the highest number of services.

In Band III transmission areas (such as the UK), use a multi-element Yagi aerial with the elements mounted vertically, as the transmissions are vertically polarised. If you are close to more than one transmitter, use an omnidirectional or folded dipole aerial.

If the DAB services in your area are transmitted on L-band, then ask your dealer for advice for the best aerial to use.



other connectors

Serial connector

RS232 serial connector



The connector is used with control devices having an RS232 serial port (for example, Crestron and AMX touch-screen controllers).

Network connector

Networking is a large subject and only the briefest guidelines are presented in this handbook. Please contact your Lexicon dealer or specialist installer for more information about introducing the Receiver into your computer network.

For information on how to use the Receiver's network features, the USB socket, and for a list of supported file types, refer to see page E-36.

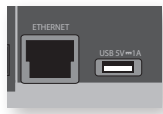

Ethernet

If an Ethernet cable is connected, the Receiver will automatically attempt to connect to your network.

You should use CAT5 cable plugged into the RJ45 socket labelled **ETHERNET** on the rear panel.

If your network uses static IP addressing rather than DHCP, you will need to provide IP address, gateway and DNS; see page E-31 for information on setting up the network.

USB connector

The Receiver can play files stored on a USB mass storage device, typically a thumb drive, but any USB device that complies with the 'mass storage device' class is compatible.

The Receiver only supports the direct connection of USB devices and will not support devices connected through a hub. If regular access to the **USB** socket is required, you may find it convenient to use a USB extension lead; see page E-36 for details of supported file types.

Trigger connectors

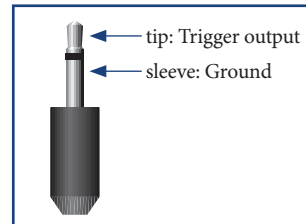

The trigger connectors (**TRIG Z1** and **TRIG Z2**) provide an electrical signal whenever the Receiver is switched on and the relevant zone enabled.

The trigger signal can be used to switch on and off compatible pieces of home entertainment equipment, for example, you could set up a trigger to turn on your television and BD player whenever the Receiver was switched on.

There are two trigger output sockets on the Receiver, each capable of outputting a 12V, 70mA switching signal. The socket is designed for mono 3.5mm jacks: tip is the trigger output, sleeve is ground.

TRIG Z1

Use for remotely turning on and off power amps or source equipment for Zone 1. On = 12V, Off = 0V.

TRIG Z2

Use for remotely turning on and off power amps or source equipment for Zone 2. On = 12V, Off = 0V.

Infrared (IR) connectors

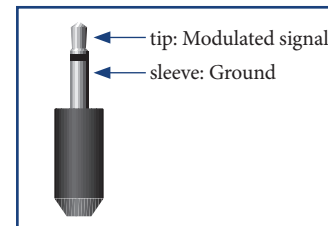

The infrared inputs (**Z1 IR** and **Z2 IR**) allow the connection of external IR receivers, either when the Receiver front panel IR receiver is fully or partially obstructed or to allow the use of a remote control in Zone 2.

There are two IR inputs on the Receiver, each designed for stereo or mono 3.5mm jacks. Tip is the modulated signal, sleeve is ground.

Z1 IR

This input is intended for use with a local IR receiver when the front panel of the Receiver is blocked.

Z2 IR

This input is intended for use with an IR receiver in Zone 2 to allow remote control of Receiver from a second room.

NOTE

Sockets referring to 'Z2' relate to connections used in multi-room installation. For more information on these connectors see page E-37.

NOTE

The IR inputs on the Receiver are designed for modulated signals. If the external IR receiver demodulates the IR signal, it will not work. Also the unit does not provide power for external receivers on the IR jack, therefore an external power source will be required.

6V output



This provides a 6V DC power connection for future accessory products requiring 6V DC.

speakers

Subwoofer

A subwoofer will greatly improve the bass performance of your system. This is useful for reproducing special cinema effects, especially where a dedicated LFE (Low Frequency Effects) channel is available, as with many discs encoded with Dolby or DTS technologies.

More than one subwoofer unit may be required for larger installations. Multiple subwoofers can also be used for sound field management, for even distribution of low frequency energy throughout the room. Ask your Lexicon dealer about multiple subwoofer placement and calibration.

Center

The center speaker allows for a more realistic reproduction of dialogue. The center speaker should have a similar tonal balance to the front left and right speakers and be positioned at a similar height.

Height speakers

With the RV-6/RV-9/MC-10 up to four height speakers can be attached and can be either mounted in the ceiling or 'Dolby enabled' elevation speakers - see page E-34 for more information.

Front left and right

Position your front left and right speakers to achieve a good stereo image for normal musical reproduction as well as for the multichannel modes. If they are placed too close together there will be a lack of spaciousness; if they are placed too far apart a stereo image will appear to have a large 'hole' in the middle and will be presented in two halves.

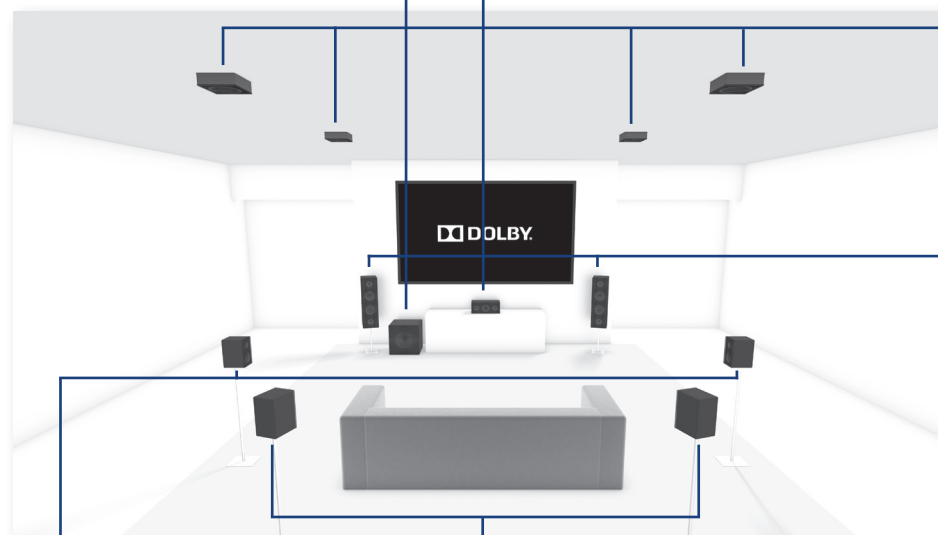

Surround left and right

The surround left and right speakers reproduce the ambient sound and effects present in a multichannel home cinema system and should be installed slightly higher than the listener's ears.

Surround back left and right

The surround back left and right speakers are used to add extra depth and better sound localisation and should be installed approximately one metre higher than the listener's ears. Place the two surround back speakers such that there is an arc of approximately 150 degrees between each surround back speaker and the center speaker. The surround back speakers should face the front of the room as shown in the diagram to provide the largest 'sweet spot'.

The RV-6/RV-9/MC-10 allows you to connect up to seven speakers and up to two active subwoofers in the main system. The output channels correspond to speakers installed in the front left, center, front right, surround left, surround right, surround back left, surround back right, height 1 right, height 1 left and an active subwoofer. In addition, up to four height speakers can be attached using an additional power amplifier, see page E-16 for more information.

With the addition of correctly installed and configured height channels, Dolby Atmos for the home brings the ultimate cinema sound experience to your home theatre to create powerful, moving audio that flows around you.

The configuration and placement of your speakers is very important. All speakers, with the exception of the subwoofer(s), should be arranged around your normal viewing/listening position. The subwoofer should be placed in a position which gives an even frequency response in all listening positions. Incorrect placement leads to bass boom in some areas. Often the only way to find a good position for your subwoofer(s) is by experimentation. A good place to start experimenting is close to a wall but at least 1m away from any corners. You can also consult your subwoofer handbook for placement suggestions.

Connecting speakers

To connect each of the speakers, unscrew the corresponding terminals on the back of the Receiver, insert the speaker wires through the hole in each post and screw the terminals back up. Make sure that the red (positive/+) terminal of the speaker is connected to the red (positive/+) terminal on the back panel, and the black (negative/-) terminal of the speaker is connected to the black (negative/-) terminal on the back panel.

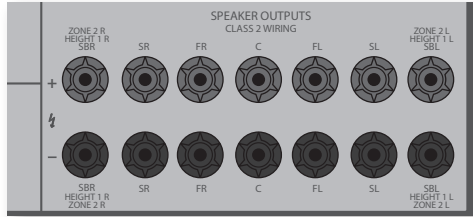

It is important that no stray strands of wire from these connections are allowed to touch another cable or the product casing. Failure to ensure this can cause a short circuit and damage your Receiver.

Do not over-tighten the loudspeaker terminals, or use a wrench, pliers, etc., as this could damage the terminals and this would not be covered under the product's warranty.

Speaker cables

The speakers should be connected to the amplifier using good-quality, high-purity, low impedance copper cables. Cheap speaker cables should be avoided – they are a false economy and can significantly degrade the sound quality.

The cable runs to the speakers should be as short as practicable. Connections to the speaker terminals should always be finger tight, whether using bare wires or spade connectors.

Bi-amping the Front Left & Front Right speakers

Bi-amping is the use of two amplifier channels per speaker. Bi-amping can provide better sound quality than conventional single wiring. If you do not have Surround Back speakers (i.e. you have a 5.1 surround system, not a 7.1 system) then you can use the spare Surround Back speaker outputs to bi-amplify the front left and right speakers, if your speakers support bi-amping. The spare channels can alternatively be used to power stereo speakers in another room (Zone 2).

Speakers that support bi-amping have two sets of +/- terminals per speaker, usually linked together by metal strips. These metal strips **MUST** be removed when bi-amping; failure to remove them will result in damage to the amplifier that is not covered under warranty.

To bi-amp the front left and right speakers, remove the metal strips from the speaker terminals. Connect the woofer or LF terminals to the FL and FR terminals on the Receiver. Connect the tweeter or HF terminals to the SBL and SBR terminals on the Receiver. Finally, navigate to the Setup Menu 'Spkr Types' and set the 'Use Channels 6+7' menu option to 'BiAmp L+R'; see page E-26.

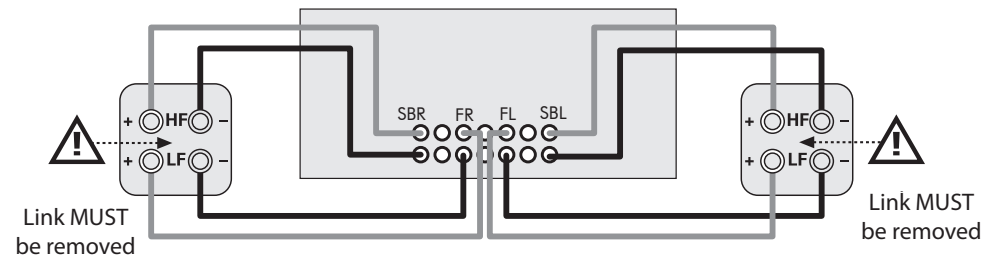

Connecting subwoofers

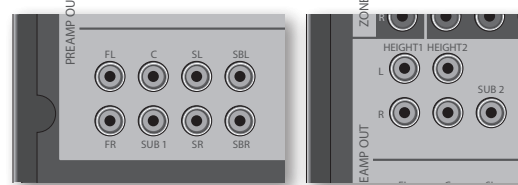

The Receiver also allows up to two active subwoofer to be connected to the **SUB** outputs. Refer to your subwoofer handbook for the correct setting up and connection procedure for your particular subwoofer(s).

Using external power amplifiers

The internal power amplifier of the Receiver (SR250 L, R, Sub only) can be supplemented or replaced with external power amplification, such as the Lexicon P49 (recommended gain 31dB). Connect the **PREAMP OUT** sockets to your power amplifier inputs:

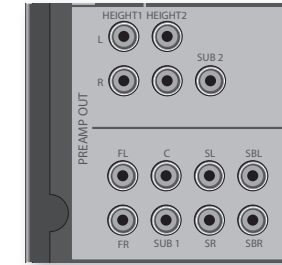

FL, FR

Connect these to the equivalent Right and Left front channels of your power amplifier. For the SR250, only this and the sub outputs are available

C

Connect these to the Center front channel of your power amplifier.

SUB

Subwoofer outputs. Connect this to the input of your active subwoofer(s), if present. For the SR250, only this and the FL, FLR outputs are available

SR, SL

Surround Right and Surround Left outputs. Connect these to the Surround Right and Left power amplifier inputs.

SBR, SBL

Surround Back Right and Surround Back Left outputs (only used in 7.1 channel systems). Connect these to the Surround Back Right and Surround Back Left power amplifier inputs.

Height 1, Height 2

Height 1 and Height 2. Connect these to the Height 1 and/or Height 2 power amplifier inputs.

All preamplifier analog outputs are buffered, have a low output impedance and are at line level. They are able to drive long cables or several inputs in parallel if required.

Operating your Receiver

For information display we recommend you use the OSD (On-Screen Display) on your display device whenever possible.

Switching on

Press the front panel power button in. The power LED will glow green, the front display shows the word 'LEXICON'. When initialisation is complete, the display shows the volume setting and the name of the selected input.

Please wait until the unit has finished initialising before operating the Receiver. It is recommended that if the unit is switched off, you should wait at least 10 seconds before switching the unit back on.

Standby

The Receiver has a standby mode which can be entered by pressing **STANDBY** on the remote control. When in standby mode, the display is blank and the **POWER** LED glows red.

If the unit is to be left unused for an extended period, we recommend that you disconnect it from the mains supply to save power.

To switch on from standby

Press the **STANDBY** button on the remote control, any key on the front panel (other than the power button) or rotate the volume knob.

Front panel display

The Receiver is ready for use after about four seconds.



The display window shows the currently selected source and the last selected information view setting (this information line can be changed using the **INFO** button).

The current volume setting for Zone 1 (37.0dB in the above example) is displayed on the front panel. The volume setting for Zone 2 is displayed temporarily whenever it is adjusted.

Selecting a source

To select a particular source, press the **-INPUT** or **INPUT+** buttons until that source is shown on the front panel display, or (if available) press the corresponding

source button on the remote. The following sources are available:

STB	Set Top Box input
GAME	Game console input
AV	Audio-Visual input
SAT	Satellite input
BD	Blu-ray Disc/DVD player input
VCR	Video Cassette Recorder input
PVR	Personal Video Recorder input
CD	Compact Disc player input
FM	Internal tuner input
DAB	Internal tuner input (this source is market dependent and may not be available on your Receiver)
NET	Ethernet input
USB	External USB solid-state device (e.g. pen drive, iPad) input
AUX	Auxiliary (front panel) input
DISPLAY	The Audio Return Channel (ARC) from a compliant display. Use this with a compliant television using internal TV tuners.

Most audio inputs have both analog and digital connections. You must specify the type of connection used for each input using the '**Audio Source**' option in the 'Input Config.' menu, see page E-29. Note that an incorrect setting will result in no sound — the default is HDMI audio. If you are not using HDMI audio then this setting must be changed.

The processing mode and Stereo Direct functions are remembered and recalled for each individual input.

Stereo Direct

To listen to a pure analog stereo input, press the **DIRECT** button. The Stereo Direct mode automatically bypasses all processing and any surround functions. In direct mode, digital processing is shut down to improve the sound quality and reduces digital noise with the Receiver to an absolute minimum.

Note: when Stereo Direct mode is selected, no digital output is available and no bass management is performed, meaning that bass signals will not be redirected to a subwoofer.

Volume control

It is important to realise that the level of the volume indicator is not an accurate indication of the power delivered to your loudspeakers. The Receiver often delivers its full output power long before the volume control reaches its maximum position, particularly when listening to heavily recorded music. In comparison, some movie sound tracks can appear very quiet, as many directors like to keep maximum levels in reserve for special effects sequences.

Headphones

To use headphones with the Receiver, plug the headphones into the **PHONES** socket in the center of the front panel.

When headphones are plugged into the front panel **PHONES** socket, the outputs for Zone 1 are muted and the audio will be down-mixed to two channels (2.0). The two-channel down-mix is required so that the center channel and surround information can be heard via the headphones.

Using Zone 2

Zone 2 provides the option for the occupants of the master bedroom, conservatory, kitchen, etc. to view or listen to a different source at a different volume level from the main zone (Zone 1).

Source selection and volume control for Zone 2 is achieved:

- by using an IR receiver in Zone 2 (see “Zone 2 control connections” on page E-37), or
- by switching over to Zone 2 control by pressing the front panel zone button, or
- by pressing **AMP + OK** on the remote control.

The front panel VFD display indicates that control has been switched to Zone 2.



To turn on Zone 2, with the remote, **AMP + OK** then press the standby power button on the remote control or press **ZONE** button on the front panel and then release it to select zone 2, then press and hold the **ZONE** button on the front panel to turn on Zone 2. Press a source select button to select a different source to Zone 1.



Note that Zone 2 control from within Zone 1 will pass automatically back to Zone 1 control after a few seconds of inactivity.

Zone 2 can also be controlled using a third-party programmable remote control or a home automation system. Please contact your dealer or installer for further details.

Extended front panel menu

Pressing the **MENU** key on the front panel and holding it for longer than four seconds will bring up the Extended Menu, allowing you to perform the following:

Restore to factory defaults

This option allows you to restore all settings on your Receiver to the defaults that it left the factory with.

Change remote code

The default RC5 system code the Receiver responds to is 16. If required, for example due to another device in your system also using this RC5 system code, it can be changed to 19.





Restore secure backup

This option allows you to restore all settings to their state as saved using the ‘Store secure backup’ feature. This option is useful if settings are accidentally changed. It also allows the unit to be returned to the saved state following a firmware update.





Store secure backup

This option allows you to save all the Receiver settings to a secure area of memory. The settings can be retrieved using the Restore option above.

– Enter PIN

Enter the secure backup PIN using the , ,  and  keys on the remote control (do not use the numeric keypad). The default PIN is 0000.

– Change PIN

Allows the PIN to be changed to a number other than the default. Enter the current secure backup PIN using the , ,  and  keys on the remote control (do not use the numeric keypad). The default PIN is 0000. After the current PIN has been entered correctly, enter a new PIN as prompted and again to confirm.

– EXIT

Cancel and return to the extended menu.

Updating firmware via USB

The firmware in your Receiver can be updated from a USB flash drive containing firmware update files.

You can download the latest firmware file, together with upgrading instructions, from the Lexicon website (www.lexicon.com).

front panel operation

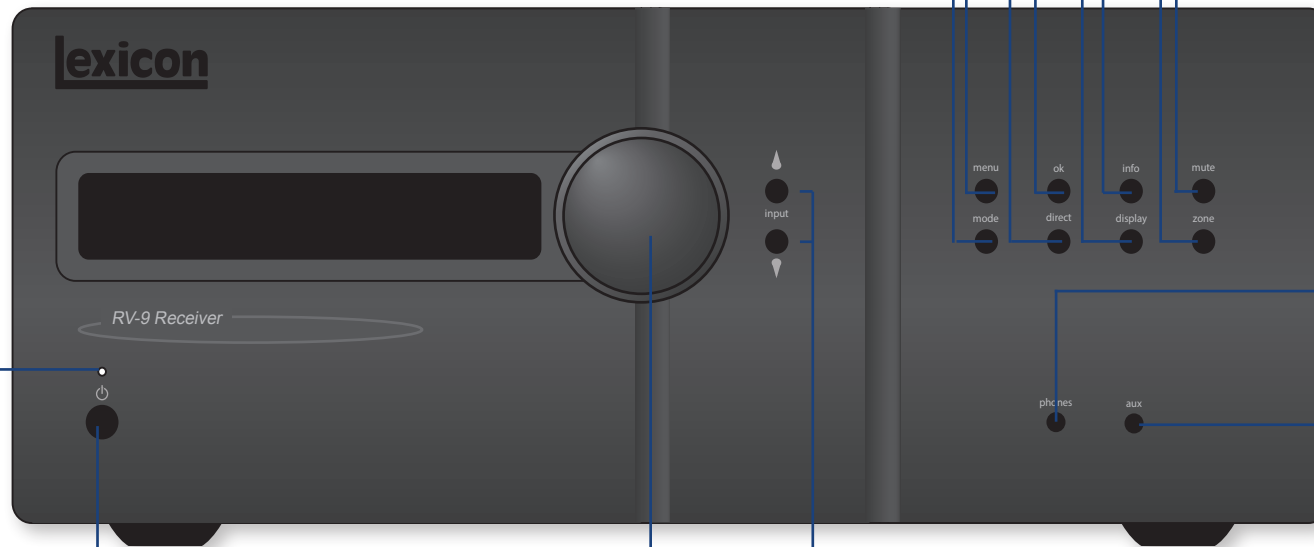

OK
Used to enter selections made in the Setup menu.

Direct
Stereo Direct on/off. Provides a direct analog path from the analog inputs to the left and right front outputs. Switches off any surround processing modes and shuts down the DSP circuits for best stereo sound quality.

Menu
Selects the Setup menus on the on-screen display (OSD).

Mode
Selects between Stereo and the available surround modes for the current source.

Display
This switches the display brightness between off/dim/bright.

Info
Selects the information displayed on the lower left portion of the front panel.

Zone
Selects between Zone 1 and Zone 2 control.

Mute
Mutes all analog audio outputs in the currently selected zone.

Power/Standby LED

This indicates the status of the receiver and is green when the Receiver is powered on. Red indicates the unit is in Standby mode.

Power

Switches the main power to the Receiver on and off. Once the unit is switched off, it should be left for at least ten seconds before switching on again.

Volume

Adjusts the analog output volume in the selected zone (line out, speakers and headphones).

Input

These buttons select the source connected to the corresponding input (or internal input) Unused sources can be prevented from being selected in the setup menu by blanking the name in MENU > Input Config.

Phones

This socket accepts headphones with an impedance rating between 32Ω and 600Ω, fitted with a 3.5mm stereo plug.

Aux

Auxiliary line level input.

Remote control receiver. This is positioned behind the display window, above the MENU button on the front panel. Ensure the receiver is in a clear line of sight from the remote control for operation. If this is not possible, use a separate sensor connected to the Z1 IR input on the rear panel.

remote control

The universal remote controller

The Receiver is supplied with a sophisticated 'universal' backlit remote control that can control up to eight devices. It is pre-programmed for use with the Receiver.

With its extensive built-in library of codes, it can also be used with thousands of third party audio-visual components – TVs, satellite and set-top boxes, PVRs, CD players, etc. See the list of codes at the back of this handbook, beginning on page 47.

It is also a 'learning' remote, so you can teach it almost any function from an old single-device remote.

Using the remote control

Please keep in mind the following when using the remote control:

- Ensure there are no obstacles between the remote control and the remote sensor on the Receiver. The remote has a range of about 7 metres. (If the remote sensor is obscured, the Z1 IR remote control input jack on the rear panel is available. Please consult your dealer for further information.)
- Remote operation may become unreliable if strong sunlight or fluorescent light is shining on the remote sensor of the Receiver.
- Replace the batteries when you notice a reduction in the operating range of the remote control.



Inserting batteries into the remote control

1. Open the battery compartment on the back of the handset, by sliding its cover off.
2. Insert two 'AAA' batteries, as indicated in the battery compartment.
3. Slide the battery compartment cover back firmly into its locked position with a click.

Notes on batteries:

- Incorrect use of batteries can result in hazards such as leakage and bursting.
- Do not mix old and new batteries together.
- Do not use non-identical batteries together – although they may look similar, different batteries may have different voltages.
- Ensure the plus (+) and minus (-) ends of each battery match the direction indicated in the battery compartment.
- Remove batteries from equipment that is not going to be used for a month or more.
- When disposing of used batteries, please comply with governmental or local regulations that apply in your country or area.

Useful information

Backlight

A backlight comes on for eight seconds whenever a key is pressed. This helps you use the handset in subdued lighting conditions.

LED blinks

Short blinks indicate a valid key press.

Multiple short blinks convey information (such as a device code) or signal the beginning and successful completion of a programming sequence.

The symbol  is used in the manual to indicate an LED blink.

Timeouts and unassigned keys

Time out – After 30 seconds the remote exits the programming state and returns to normal operation.

Stuck key timeout – After any key is pressed continuously for 30 seconds, the remote stops sending IR transmission to conserve battery life. The remote remains off until all keys are released.

Unassigned keys – the remote ignores any unassigned key presses for a particular Device Mode and does not transmit IR.

Low voltage indicator

When the batteries are running down, the backlight flashes briefly whenever you press a button.

If this happens, fit two new AAA alkaline batteries as soon as possible.



Device Mode/Source keys

As the remote can control your Receiver as well as a range of other equipment: many of the buttons have more than one function depending on the 'device mode' selected on the remote control.

The Device Mode keys (shown below) select the source on the Receiver. If one of these keys is pressed briefly, a command is transmitted to change the source on the unit. Also the functionality of the remote control changes to operate the selected source device; it's like having a bundle of different remotes in your hand!



RADIO	Internal FM or DAB tuner input
AUX	Auxiliary input
NET	Ethernet input (e.g. Internet radio)
USB	External USB device (audio files on pen drive, etc.)
AV	Audio-visual sound input (use with TV)
SAT	Satellite input
PVR	Personal Video Recorder (or Digital Video Recorder) input
GAME	Games console input
BD	Blu-ray Disc or DVD player
CD	Compact Disc player input
STB	Set Top Box decoder input
VCR	Video Cassette recorder input

Each Device Mode changes the behaviour of many of the remote keys to control the source device appropriately. For example: in CD mode  plays the previous CD track, but in AV mode  issues the TV 'channel down' command.

The remote remains in the last selected Device Mode so it is not necessary to press a Device Mode key before every command key if all you are doing is playing or skipping tracks on a CD, for example.



Navigation keys

The Navigation keys steer the cursor in Setup menus or on-screen menus. They also replicate the navigation functions of original remotes supplied with other home entertainment devices in your system. OK confirms a setting.

Volume control

By default, the remote is set up so that the volume control and mute buttons always control the volume of the Receiver, regardless of which Device Mode the remote is currently set for. This is known as volume 'punch through'.

For example, if you are listening to a CD, you will probably have the remote in CD Device Mode to control the CD player. You can use the volume controls on the remote directly to adjust the volume of the Receiver without first having to press AMP to put the remote into AMP Device Mode. The volume buttons 'punch through' the CD Device Mode on the remote to the AMP Device Mode.

Volume 'punch through' can be disabled individually for any Device Mode if desired.

Customising the remote

The remote offers a Code Learning feature that allows you to copy up to 16 functions from an original remote control onto the remote keypad. For details of this, and other customisation features, see "customising the remote" on page E-38.

The remote complies with Part 15 of the FCC rules

This equipment has been tested and found to comply with the limits for a class B digital device, pursuant to part 15 of the FCC Rules. These limits are designed to provide a reasonable protection against harmful interference in a residential installation. This equipment generates, uses, and can radiate radio frequency energy and if not installed and used in accordance with the instructions, may cause harmful interference to radio communications. However, there is no guarantee that interference will not occur in a particular installation. If this equipment does cause harmful interference to radio or television reception, which can be determined by turning the equipment off and on, the user is encouraged to try to correct the interference by one or more of the following measures:

Reorient or relocate the receiving antenna.

Increase the separation between the equipment and receiver.

Connect the equipment into an outlet or a circuit different from that to which the receiver is connected.







Consult the dealer or an experienced radio/TV technician for help.









AMP

AMP Device Mode

The **AMP** Device Mode button configures the remote to control the Receiver. Pressing this button does not affect the currently selected input on the Receiver.





The functionality of the remote is context sensitive for the internal sources and is described in the following table.

	Single press – Toggles Receiver power between standby and on in the current zone (zone in which the command is received). Press and hold – Forces all zones into standby, regardless of which zone the command was received in.
0.....9	The number keys can be used for direct entry of numeric values
SYNC	Sync. Delays may be introduced into the video signal by video processing which causes a mismatch between the audio and video timing. You will notice this by speech sound being out of synchronization with the lip movements in the video. To compensate for this, you can adjust the lip sync delay. Press the SYNC button and use the  and  navigation buttons. Press again to exit the lip sync trim menu.
INFO	Info cycles through the information displayed on the lower left portion of the front panel display when on TUN , NET and USB inputs.
	Brings up the DTS:X dialogue control adjustment.
MENU	Displays the unit's setup menu on the On Screen Display.
POP UP	Toggles Dolby Volume on/off.
AUDIO	Toggles Dirac Live EQ on/off.
RTN	Brings up a temporary subwoofer trim control. Use the  and  navigation buttons. Press RTN again to exit the sub trim control. As this is a temporary adjustment, the sub trim level is reset to the value set in the Speaker Levels menu when the unit is turned off or put into standby.

	Toggles the mute function of the AVR.
VOL	Adjust amplifier volume.
MODE	Cycles through the available surround and downmix modes.
DISP	Cycles through the front panel display's brightness options
AMP	Resets remote to AMP mode.
DIRECT	Stereo direct on/off. Provides a direct analog path from the analog inputs to the left and right front outputs. Switches off any surround processing modes and shuts down the DSP circuits for the best stereo sound quality.
	Navigate the files and menus on the screen. OK selects the highlighted file or enters the highlighted menu on the screen – equivalent to 'Enter' or 'Select' on some remote controls.  Up  Left  Right  Down AMP +  Power on from standby AMP +  Standby from Power on AMP + OK select Zone 2
RED	Red button.
GREEN	Green button.
YELLOW	Yellow button.
BLUE	Blue button.
RADIO	Tuner input.
AUX	Aux input.
NET	Network (NET) input.
USB	USB input.
AV	AV input.
SAT	SAT input.
PVR	PVR input.
GAME	Game console input.
BD	BD input.
CD	CD input.
STB	STB input.
VCR	VCR input.







USB commands

The USB interface is selected by pressing **USB** in **AMP** Device Mode on the remote. When connected to a device storing music files connected by USB, the keys below are used to navigating music tracks.

	Navigates the files on screen. OK selects/plays the highlighted file.
	Selects the previous/next track in the current playlist.
	Selects the previous/next track in the current playlist.
	Pause and playback of the current track.
	Stops playback..

Network commands









When using the network client, the keys below are used to navigate music files in **AMP** Device Mode.









	Navigates the files on screen. OK selects/plays the highlighted file.
	Selects the previous/next track in the current playlist.
	Selects the previous/next track in the current playlist.
	Pause and playback of the current track.
	Stops playback..
RED	Adds the currently displayed radio station to the favourites list when using the network client.
GREEN	Removes the currently displayed radio station to the favourites list when using the network client.
	Returns navigation to the top level of the network client menus ('Home')

BD

BD/DVD Device Mode

The **BD** Device Mode button configures the remote to control the functions of Lexicon Blu-ray Disc and DVD players, although this can be changed. Pressing this button also selects **BD** as the source.





	Toggles power between standby and on.
	Open/close disc tray.
0...9	Searches for and plays the track corresponding to the key pressed when playing a CD.
DISP	Cycles through the front panel display's brightness options.
MODE	Cycles through the repeat options (track, disc, etc.).
	Fast rewind.
	Fast forward.
	Press and release to skip back to the beginning of the current/previous track.
	Press and release to skip forwards to the beginning of the next track.
	Stop playback of a BD or DVD.
	Pause and playback of the current track.
	Start recording (on products that have this feature).
MENU	Disc menu.
POP UP	Activates BD/DVD player menu, if available.

	Navigate setup and BD/DVD programme selection menus. OK selects the highlighted file or enters the highlighted menu on the screen – equivalent to 'Enter' or 'Select' on some remote controls.  Up  Left  Right  Down BD +  Power on from Standby BD +  Standby from Power on BD +  changes the picture resolution (for BD, only on the Home screen).
	Returns navigation to the top level of the menu ('Home').
AUDIO	Changes audio decode format (Dolby Digital, DTS, etc.).
AMP	Resets remote to AMP mode.
RED	RED button for BD
GREEN	GREEN button for BD
YELLOW	YELLOW button for BD
BLUE	BLUE button for BD.

AV

AV Device Mode

The **AV** Device Mode button configures the remote to control the functions of a television or other display device. You will need to configure this Device Mode to work with your equipment. Pressing this button also selects **AV** as the source.

	Toggles power between standby and on. (Some TVs require you to use a number key to turn them on).
0...9	Functions as original remote number key – usually for channel selection.
DISP	Display INFO or OSD (On Screen Display) function, if available.
MODE	AV; this function is TV specific.
	Channel down.
	Channel up.
INFO	Displays picture information; this function is TV specific.
POP UP	Guide.
	Navigate setup and programme selection menus. OK confirms a selection (equivalent to 'Enter' or 'Select' on some remotes).
	Returns navigation to the top level of the menu ('Home').
AMP	Resets remote to AMP mode.
RED	RED key for Text TV
GREEN	GREEN key for Text TV
YELLOW	YELLOW key for Text TV
BLUE	BLUE key for Text TV.

VCR











VCR Device Mode

The **VCR** Device Mode button selects **VCR** as the source. The VCR page allows code learning from a dedicated VCR remote – see “customising the remote” on page E-38.

STB

STB Device Mode





The **STB** Device Mode button selects **STB** as the source. If configured to work with your set top box decoder or similar device, the remote can subsequently control the device.

	Toggles power between standby and on.
0..9	Functions as original remote number key – usually for channel selection.
DISP	Display INFO or OSD (On Screen Display) function, if available.
MODE	Selects the Library or Media function.
	Rewind.
	Fast Forward.
	Channel down.
	Channel up.
	Stop playback.
	Pause and playback of the current track.
	Record.
INFO	Opens the EPG (Electronic Program Guide) on some satellite and cable set top boxes.
POP UP	Turns on the Menu function if the set top box uses this feature.
	Navigate setup and programme selection menus. OK confirms a selection (equivalent to 'Enter' or 'Select' on some remotes).
	Returns navigation to the top level of the menu ('Home').
AUDIO	Selects the Help function.
AMP	Resets remote to AMP mode.
RED	RED button for set top box.
GREEN	GREEN button for set top box.
YELLOW	YELLOW button for set top box.
BLUE	BLUE button for set top box.

SAT

SAT Device Mode











The **SAT** Device Mode button selects **SAT** as the source. If configured to work with your satellite receiver, the remote can subsequently control the device.

	Toggles power between standby and on.
0..9	Functions as original remote number key – usually for channel selection.
DISP	Display INFO or OSD (On Screen Display) function, if available.
	Channel down.
	Channel up.
INFO	Displays programme information.
POP UP	Guide (or Setup on some set top boxes).
	Navigate setup and programme selection menus. OK confirms a selection (equivalent to 'Enter' or 'Select' on some remotes).
	Returns navigation to the top level of the menu ('Home').
RTN	Back.
AMP	Resets remote to AMP mode.
RED	RED button for Satellite.
GREEN	GREEN button for Satellite.
YELLOW	YELLOW button for Satellite.
BLUE	BLUE button for Satellite.

PVR

PVR Device Mode

















The **PVR** Device Mode button selects **PVR** as the source. If configured to work with your personal (hard disc) video recorder or similar device, the remote can subsequently control the device.

	Toggles power between standby and on.
0..9	Functions as original remote number key – usually for channel selection.
INFO	Display INFO or OSD (On Screen Display) function, if available.
MODE	Selects the Library or Media function.
	Rewind.
	Fast Forward.
	Channel down.
	Channel up.
	Stop playback.
	Pause and playback of the current track.
	Record.
MENU	Opens the EPG (Electronic Program Guide) on some satellite and cable set top boxes.
POP UP	Turns on the Menu function if the PVR uses this feature.
	Navigate setup and programme selection menus. OK confirms a selection (equivalent to 'Enter' or 'Select' on some remotes).
	Returns navigation to the top level of the menu ('Home').
AUDIO	Selects the Help function.
AMP	Resets remote to AMP mode.
RED	RED button for PVR.
GREEN	GREEN button for PVR.
YELLOW	YELLOW button for PVR.
BLUE	BLUE button for PVR.

CD Device Mode

The **CD Device Mode** button selects **CD** as the source.

The button is configured to control the CD functions of Lexicon CD players, although this can be changed (see "Locking/Unlocking a specific Device Mode" on page E-39).

	Toggles power between standby and on.
	Open/close disc tray.
0...9	Searches for and plays the track corresponding to the key pressed.
DISP	Cycles through the front panel display's brightness options.
MODE	Cycles through the repeat options (track, disc, etc.).
	Fast rewind.
	Fast forward.
	Press and release to skip back to the beginning of the current/previous track
	Press and release to skip forwards to the beginning of the next track.
	Stop playback of a CD
	Pause and playback of the current track.
POP UP	In 'normal play' (i.e. the display does not show the letter P), press the  and  keys to select the track and then MENU stores the track. In 'program play' mode, the MENU key deletes the stored track.
	Navigate setup and CD programme selection menus. OK selects the highlighted file or enters the highlighted menu on the screen – equivalent to 'Enter' or 'Select' on some remote controls.  Up  Left  Right  Down CD +  Power on from Standby CD +  Standby from Power on.

AMP	Resets remote to AMP mode.
RADIO	Plays the programmed tracks.

essential setup

Before you use your Receiver it is essential that you enter some information into the Setup menus about your speaker configuration. This allows the Receiver to process any surround sound digital source to exactly match your system and give you the ultimate surround sound experience.

There are three pieces of vital information which are outlined in the sections: 'Speaker Types', 'Speaker Distances' and 'Speaker Levels'.

The way you enter this information manually into the Receiver is given later in the 'Setup Menus' section on page E-28. The settings can also be established automatically using the Lexicon Auto Speaker Setup function. However it is important to understand why these speaker settings must be entered, which is why this section is presented first.

Speaker types

You need to set the type of speakers that you have connected to your Receiver:

Large	capable of full frequency range reproduction
Small	not capable of full frequency range reproduction at the low frequency end
None	speaker not present in your configuration

The terms 'Large' and 'Small' do not necessarily relate to the physical size of your speakers. As a rule of thumb, if a speaker cannot reproduce a flat frequency response down to about 40Hz (and very few can!) it is often better to consider them as 'Small' for setup purposes of home cinema.

When a speaker is set to 'Small', very low frequency sounds are redirected away from that speaker to a 'Large' speaker or a subwoofer, which are far better suited to reproducing these low frequency sounds.

Note that it is not possible to set all speakers to 'Small' unless there is a subwoofer in your speaker configuration. If you do not have a subwoofer, you will be forced to set your front speakers to 'Large'.

(Advanced users may wish to automatically override the 'Small' speaker setting for purely stereo music listening when not watching movies. This can be achieved in the 'Input Config' menu – see page E-29.

Crossover frequency

If you have set any speakers as being Small, then you will be required to set a value for the crossover frequency. This is the frequency below which signals are filtered away from these Small speakers and redirected to Large speakers or the subwoofer (if present). A frequency of 80Hz is often a good starting point, however you will probably have to experiment with different values to find the best value for your system or consult your speaker handbook.

Use Channels 6+7 for

If not used in the main zone, it is possible to assign the Surround Back channels to Height 1, bi-amp the Front Left/Right channels or to provide an amplified output to Zone 2.

Speaker Distances

It is essential for the distance from each speaker to the listening position to be accurately measured and entered into the 'Setup' menu. This ensures that the sounds from the various speakers arrive at the listening position at the correct time to recreate a realistic surround effect. The distance can be entered in centimetres or inches.

Speaker Levels

Finally the levels of all the speakers in the system need to be adjusted to match each other at the listening position, again to create a proper surround effect. To help with this the Receiver can generate a test noise for each speaker which should be measured with a sound pressure level (SPL) meter. The meter should be set to 'C' weighting and slow response. Several smartphone/tablet apps are available which can also perform this function. The level of noise measured at the listening position from each speaker should be adjusted on the Speaker Trims page of the Setup menu so that the meter reads 75dB SPL. It does not matter what the system volume setting of the Receiver is before turning the test noise on as the volume setting is over-ridden for the duration of the speaker noise test.

There are several basic SPL meters on the market at reasonable prices aimed at home cinema enthusiasts. Check your local technology store, search online or ask your dealer.

If you do not have an SPL meter or suitable app, you can try to adjust the noise level of each speaker by ear. In this case it is not possible to adjust the speakers to the absolute 75dB SPL volume level, but you should aim for all speakers sounding equally loud. Setting speaker test noise levels by ear is not recommended as it is very difficult to do accurately, but is often better than doing nothing at all!

auto speaker setup



Dirac Live for Lexicon

There is a proprietary automatic loudspeaker setup function built into your Receiver from Dirac Research. Using a PC/MAC based application, this attempts to set all the essential speaker settings for all the speakers in your system. It also calculates room equalisation (Room EQ) filter values to remove some of the worst effects of resonant frequencies in the listening room.

Your Receiver package is supplied with a calibration microphone, which should be inserted into the microphone input of the supplied USB sound card and then into a USB socket on a PC or MAC connected to the same network as the Receiver and positioned as directed by the Dirac Live for Lexicon PC/MAC application. This microphone picks up the special calibration tones generated by the speakers when Dirac Live for Lexicon application is run. The Receiver then analyses the signal and computes:

- speaker type,
- speaker distance,
- speaker level,
- problem resonant frequencies in the room which need control by filtering.

To help the system be as accurate as possible when performing Dirac Live for Lexicon setup, there are a few guidance rules that should be followed:

- Minimise any background sounds in the listening room and other nearby rooms.
- Close all windows and doors in the listening room.
- Turn off all fans including air-conditioning systems.
- Mounting the microphone on a tripod or similar.
- Position the set up microphone pointing upwards at roughly head height in the normal listening position. It is not necessary to point the microphone directly at the speaker generating the test tone. (It helps if you are able to position the microphone exactly where your head would normally be for listening, with the microphone in direct unobstructed view of all speakers.)
- If your system includes an active subwoofer, start by setting its output level/ gain control to a value roughly matching the front speakers.

When activated, a calibration tone is played through each channel of the Receiver in turn, including the subwoofer channel. The calibration tone cycles round each of the speakers multiple times as the different parameters are calculated. If you do not have a full 7.1 speaker (on the “floor”) configuration there will be periods of silence between some speaker channels. Follow the ‘progress’ information on your PC/MAC.

By default, Room EQ is not applied to any of the source inputs. You should enable Room EQ on inputs you think benefit from this feature, as required, by listening when playing typical source material through each input. After being calculated, this is enabled from within the Input Config menu.

While room equalisation can help to reduce problems with listening room acoustics, it is usually far better to try to solve these problems with the room directly. Proper loudspeaker positioning, acoustic wall treatments and moving the listening position away from walls should produce far better results overall. However it may be difficult to do this in a home environment, so Room EQ is your next best choice.

Problems

We advise you to look over the reported measurements on the screen following Auto Speaker Setup for any obviously incorrect results, in particular to ensure the reported speakers match your configuration and that the speaker distances to the listening position appear roughly correct. If the results are not what you expected re-run Auto Speaker Setup.

The Auto Speaker Setup function is normally quite accurate but occasionally false results can be generated. Problems may be as a result of:

- external sounds or rumbling/handling noises picked up by the microphone
- sound reflections off hard surfaces (e.g. windows or walls) close to the listening position,
- very strong acoustic resonances within the room,
- obstacles (such as a sofa) between speakers and the microphone.

If you are still experiencing difficulties or you wish to have the most accurate results for ultimate surround performance, we recommend using the manual method of establishing speaker distances and levels.

Using subwoofers

If your system includes one or two active subwoofers you may need to set the subwoofer output level/gain control set to a higher or lower value.

Please refer to the Dirac application and quick start guide for full details of how to use the system with your Receiver.

Downloading the Dirac Live for Lexicon application

To download the Dirac Live for Lexicon PC/MAC application and quick start guide, please visit:

www.lexicon.com

setup menus

The Setup menus allow you to configure all aspects of your Receiver. The next few pages will go through the menu items and explain their function. The Setup menus will probably look quite daunting if you are new to setting up home cinema, but the majority of them need only be configured once when you first install the system (or if your system changes or you move house!)

The only way to view the Setup menus is on your display device (TV or projector) using the on-screen display (OSD) capability of the Receiver. To view the OSD for the initial setting up, connect any of the video outputs to your display device. You do not need to have a video source connected to the Receiver video inputs.

Entering Setup mode

To enter the setup menu, press the **MENU** button on the remote control or front panel. The front panel display shows 'SETUP MENU' and the setup menu (pictured right) is displayed.

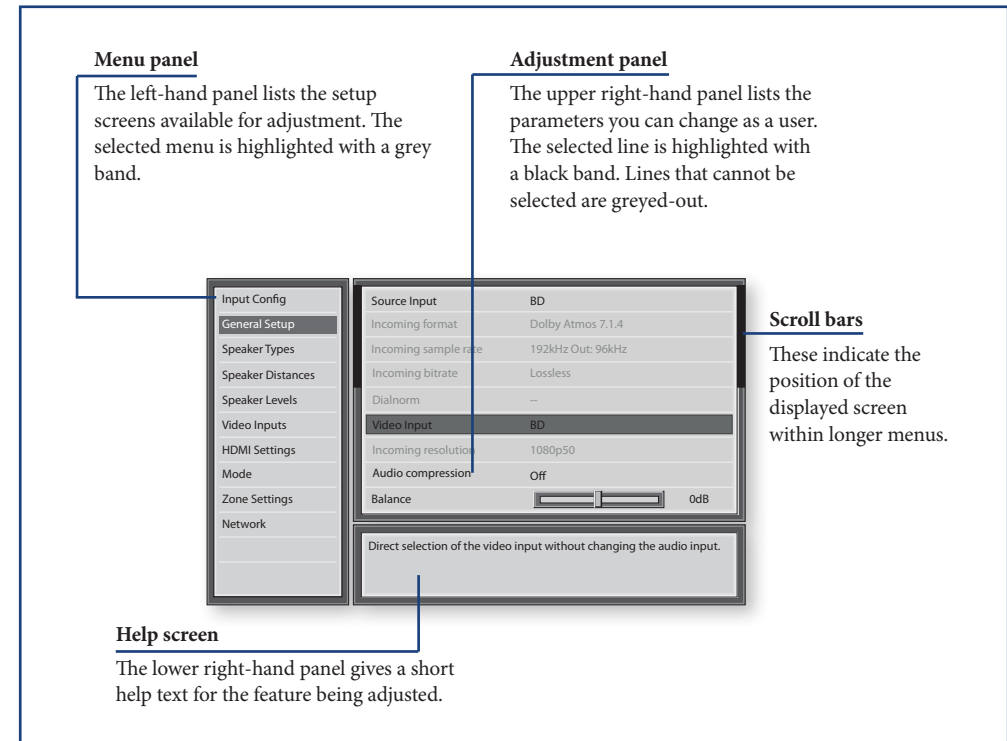

Navigating the setup menu

... using the remote control

The setup menu can be navigated by using the cursor (arrow) keys on the remote control. This is by far the easiest method.

1. To enter the setup menu, press the **MENU** button (which is located immediately under the navigation buttons).
2. Use the **▲** and **▼** keys to navigate up and down the main section headings in the left-hand panel.
3. Once you have the main section that you require highlighted, use the **▶** key to enter the section.
4. Use the **▲** and **▼** keys to navigate up and down the section settings in the right-hand panel. Some settings may be greyed out. These are either for information only (e.g. incoming sampling frequency)

or are not currently selectable (e.g. network IP address when DHCP is used). Scroll bars on the sides of the right hand panel indicate your position in the settings list where there are more items than can be displayed at once.

5. Pressing **OK** selects a setting to change it, pressing **OK** again de-selects the setting.
6. At any time, press the **MENU** button to exit the menu. Any changes to settings are saved.

... using the keys on the front panel

The Receiver front panel controls can be used to configure the unit. Follow the instructions for using the remote control, in this case using **INPUT-** for down, **INPUT+** for up, **INFO** for left and **MODE** for right.

Input Config.

The audio and video settings on this page of the Setup menu can be tailored *specifically and independently to the currently selected input.*

When a different input is selected on the Input line, all the input-specific settings for that input are displayed below it. These settings are applied to the named Input only and are stored in memory and recalled each time the unit is powered up and whenever that input is selected.

Input – The currently selected input connectors to which the settings below relate.

Name – The display name of the input. You can change the name of any input to more closely match your setup. For example, if you had two satellite receivers, you could connect the main receiver to the Sat audio and video input connectors and change the Name to 'SAT 1'. You could then connect the second satellite receiver to the VCR audio and video input connectors, but change the VCR Name to 'SAT 2'. It is then clearer to users of your Receiver which inputs they wish to select when scrolling through.

Lip Sync – Each input can have its own setting to add a time delay between the audio and video signals to compensate for the sound and picture not being synchronised. This is normally required when video processing is used in the system for scaling or de-interlacing video. The range of lip sync delay is 0 to 250 milliseconds.

The lip sync adjustment can only correct for delayed video. If the audio is late set lip sync to its minimum.

Mode – Sets the initial audio decode mode for stereo sources on this input.

- Last Mode recalls the last used setting for this input when a stereo source was applied. See section "Two-channel source modes" on page E-32 for more information.

Ext. Mode – Sets the initial audio decode mode for multi-channel digital sources on this input.

- Last Mode recalls the last used setting for this input when a stereo source was applied. See section "Multi-channel source modes" on page E-32 for more information.

Bass –

Treble –

These allow you to alter the bass and treble tone controls for all currently active speakers for each individual

input. For example, if your PVR source sounds a little bass light, you can always correct for this by selecting PVR on the Input line at the top of this menu and add 2 or 3dB to the Bass control. Then, whenever the PVR input is selected, the bass is automatically boosted for as long as that input is selected.

Room EQ – When the Auto Speaker Setup function is run it also calculates Room Equalisation coefficients to remove some of the worst effects of resonant frequencies of the room at the listening position. By default Room EQ is not applied to any of the source inputs, however you can enable them on a per-input basis as you wish.

- **Not Calculated:** (Information only) Auto Speaker Setup has not been run or has errors so cannot be selected.
- **Project Name:** Dirac Live for Lexicon Room EQ is applied to the current source and will display the name of the project from the Dirac Live application.
- **Off:** Dirac Live for Lexicon Room EQ is not applied to the current source.

Input Trim – Sets the maximum analog input signal level (sensitivity) on this input before the ADC (Analog-to-Digital converter) signal path clips. Options are 1, 2 and 4 volts RMS maximum input. The default is 2Vrms maximum.

For example, analog sources with low output levels may benefit by choosing the 1V maximum setting. This helps maximise signal-to-noise performance of the Receiver and also helps keep the various analog sources sounding about the same level for any given Receiver volume control setting.

Dolby Volume – Dolby Volume is an intelligent system that improves the perceived audio frequency response at lower listening levels and corrects for volume inconsistencies between sources (e.g. a rock radio station and a BD) and between programming (e.g. a TV show and advertisement breaks).

- **On:** Dolby Volume is applied to this input.
- **Off:** (default) Dolby Volume is not applied to this input.

Dolby Leveller – This setting of Dolby Volume controls how closely quiet and loud sources and programme content are matched to each other, based on the ear's perception of loudness. The range of values is 0 (minimal levelling) to 10 (maximum levelling). The default setting is 2, however we recommend experimenting with higher values if your source material is less closely matched in level. If the Volume Leveller function is set off, no level matching between sources

and programme material is performed. Note however that turning the Dolby Leveller setting of Dolby Volume to 'Off' is not the same as turning the entire function of Dolby Volume to 'Off', as volume related frequency response processing is still active. See "Dolby volume" on page E-34 for more information.

DV Calib. Offset – The Calibration Offset parameter of Dolby Volume allows you to compensate for speaker efficiencies and listening position. The default value is 0 and this should normally produce a good result when the Receiver speaker levels are set using a sound pressure level meter.

See "Dolby volume" on page E-34 for further information on Calibration Offset.

Stereo Mode – If you have configured your system to have a subwoofer, then you have the flexibility to choose how bass information is distributed between the front left/right speakers and the subwoofer when listening to stereo (two channel only) analog and digital sources. Choose the option which gives you the most solid, even sounding bass. If you are using a subwoofer for stereo, please also see Sub Stereo below to set the level of the subwoofer. For best results test with a setup disc or live programme material. This setting can be used to override your normal speaker settings in the Spkr Types menu whenever the Receiver plays stereo material. It is quite common to find that two channel stereo music listening is best done with a slightly different sub/speaker setting than for surround movies.

- **As Spkr Types:** When an analog or digital stereo source is played, your normal speaker configuration (as in **Spkr Types** menu) is used to reproduce the signal.
- **Left/Right:** Full frequency stereo information. All audio is sent to the front left and right speakers only without any bass redirection. You can use this setting if you consider your front left/right speakers to be able to handle the full frequency range of music. If you have set your front left/right speaker size as Small in the Spkr Types setup page, you may wish to use this option to override the setting to Large for stereo music listening, if you have full frequency range left/right speakers.

It can often be beneficial to set full frequency range speakers to Small in the Spkr Types setup page for use with movies, if you have a subwoofer in your system. Doing so may deliver more impact on movie soundtracks as subwoofers are designed to handle reproduction of high bass content. However you may find that for stereo music a better overall

result is obtained by not using the subwoofer and effectively treating the front left/right speakers as Large.

- **Left/Right+Sub:** Full frequency range stereo is fed to the front left and right speakers and extracted bass is sent to the subwoofer. In this case the low frequency information is effectively duplicated.
- **Sat+Sub:** Use this setting if you really do have Small satellite front left and right speakers, or if you prefer the overall sound of bass being handled by the subwoofer. Full bass management is used so that analog and digital stereo sources are fed to the DSP where the bass is filtered off front left and right and redirected to the subwoofer.

NOTE

The Stereo Mode function is not available when using an analog source in Stereo Direct mode.

Sub Stereo – If Left/Right+Sub or Sat+Sub is selected in Stereo Mode above, this setting adjusts the level of the subwoofer when the source is two channel stereo.

Audio Source – Selects the particular connection type for each input. The default is HDMI; this setting must be changed if another connection is used.

Select from the list the audio type you are using on this source.

- **HDMI:** the unit is forced to use the HDMI audio input for this source.
- **Digital:** the unit is forced to use the optical (TOSLINK) or coaxial (S/PDIF) digital audio input for this source
- **Analog:** the unit is forced to use the analog audio input for this source.

CD Direct – Turns off the compressed audio detection mute delay and should only be used for sources that will only transmit PCM audio (e.g. a CD player).

General Setup

General information and system controls.

Source Input – (Information only) The currently selected input to which the settings below relate.

Incoming Format – (Information only) The format of the digital audio stream connected to this input, if present.

Incoming Sample Rate – (Information only) The sample rate of the digital audio stream connected to this input, if present.

Incoming Bit Rate – (Information only) The bit rate of the digital audio stream connected to this input, if present.

Dialnorm – (Information only) If a Dolby Digital audio stream is connected to this input, this is the Dialogue Normalisation setting requested by the stream.

Video Input – The currently selected video input. For inputs that have video connections (e.g. SAT, PVR etc), audio and video inputs normally switch over together. However, here you can temporarily select a different video source for the current audio source. This feature may be useful, for example, if you are watching a sports game on satellite but on this occasion wish to listen to the commentary on the radio instead. This temporary override is reset when the input source is changed so that the Video Input follows the Audio Input setting (or the setting in the Video Inputs menu, if applicable).

Incoming Resolution – (Information only) Shows the incoming video resolution.

Audio Compression – Allows selection of compression which is ideal for late night listening. The compression effect increases the volume of the quiet passages and decreases the volume of the louder passages. Compression only applies to Dolby / DTS soundtrack formats that support this function.

- **Off:** (default) no audio compression is applied.
- **Medium:** compression is applied so that loud portions of a soundtrack are reduced in level. Dolby True HD stream is compressed automatically as set by the incoming stream.
- **High:** the maximum amount of dynamic range compression is applied, so that the difference between loud and quiet portions of a soundtrack is minimised.

This setting applies to all inputs when a relevant digital audio stream is detected. It is stored in memory and recalled each time the unit is powered up.

Balance – To alter the sound balance temporarily between front left and right speakers. You can alter the sound stage to either the left or the right by up to 6dB. Note that it is not possible to shift the audio signal completely over to one channel. This function resets to equal left/right balance when the input is changed.

Dolby Center Spread – Allows adjustment of the sound field for Dolby Surround mode decoding of two-channel sources.

- **Dolby Center Spread:** Controls the center image width. With Dolby Surround decoding, dominant center signals come only from the center speaker. If no center speaker is present, the decoder splits the center signal equally to the left and right speakers to create a 'phantom' center image. The Center Spread control allows variable adjustment of the center image so it may be heard only from the center speaker; only from the left/right speakers as a phantom image; or from all three front speakers to varying degrees.

Digital Output Freq. – Sets the sampling frequency of the audio Analog-to-Digital converter. This setting applies to all inputs when analog audio is being processed (i.e. not Stereo Direct mode). It is stored in memory and recalled each time the unit is powered up.

Maximum Volume – Limits the maximum volume setting the system can be turned up to in the main zone. This is a useful feature to prevent accidental overdriving of low power-handling speakers (for example). It is stored in memory and recalled each time the unit is powered up.

Max On Volume – Limits the maximum volume the system operates in the main zone when it is switched on or comes out of Standby. The system comes on at this stored volume setting if the last used (possibly very loud) volume exceeds this value. It is stored in memory and recalled each time the unit is powered up.

Display on time – Sets the time that the front panel display remains illuminated after receiving a command. The default is always on.

CEC Control (Output 1 only) – Enables or disables HDMI CEC control, a system that allows devices connected with HDMI to control other compatible connected devices.

- **Off:** disables CEC Control
- **Output 1**

ARC Control (Output 1 only) – Enables or disables the HDMI Audio Return Channel. This allows for television sound to be sent back to the Receiver, via the 'Display' input. ARC Control depends on CEC control being set.

HDMI Audio To TV – Enables or disables the transmission of HDMI audio from the HDMI output connector. Enable this setting if you wish to be able to listen using your TV speakers.

Control – Enables or disables RS232 or IP (NET) control, a system that allows control from various third-party home automation systems. Note, only RS232 or IP control can be used, not both.

Power on – Determines how the unit powers on.

- **Stby:** in Standby mode
- **On:** On
- **Last state:** Last state (default).

Standby Mode – Determines what functionality is retained while in standby.

- **Low Power:** Lowest power setting
- **IP & HDMI ON:** Allows for IP control & HDMI bypass while in standby, but consumes more power.

Language – Select the language for the OSD menu - English, French, German, Spanish, Dutch, Russian, Chinese.

Speaker Types

Settings for the types of loudspeaker you have connected in your configuration. These settings are applied to all audio inputs and are stored in memory and recalled each time the unit is powered up.

Front Left/Right – Center – Surr. Left/Right – Surr. Back L/R – Height 1 – Height 2 – Subwoofer –

Here you set the type of speakers that you have connected to your Receiver:

- **Large:** capable of full frequency range reproduction
- **Small:** not capable of full frequency range reproduction at the low frequency end
- **None:** speaker not present in your configuration
- **Height 1, 2:** configures the type of height speakers - height/Dolby enabled.
- **Subwoofer:** Sets whether you have none, 1 or 2 subwoofer(s) present.

NOTE

It is not possible to set all speakers to Small unless there is a subwoofer in your speaker configuration. If you do not have a subwoofer, you will be forced to set your front speakers to Large.

Crossover Freq – This is the frequency at which loudspeakers set as Small start to redirect bass signals to the Subwoofer or Large speakers in your system. Small speakers redirect bass to the subwoofer, if present. The exception is the Center speaker which, if Small, redirects its bass to front left/right provided that they themselves are Large. This is done to help keep Center bass directly in front of the listening position.

Dolby Speaker Crossover – This is the frequency at which height speakers set to small redirect bass information.

Use Channels 6+7 for – If your main zone speaker set up does not include Surround Back Left and Right speakers, you can choose to use the Surround Back amplifier channels as the Height 1 amplifiers, to Bi-Amp the Front Left and Right pair, or as a stereo power amplifier for Zone 2.

Speaker Distances

Calibration settings for the distances between the loudspeakers and the listening position.

NOTE

Speakers that are not present in your configuration will be greyed out.
If Dirac Live for Lexicon is used, these settings will also be greyed out as they are autoselected by Dirac

These settings are applied to all audio inputs and are stored in memory and recalled each time the unit is powered up.

Units – Select whether you wish to measure distances in imperial or metric units.

Front Left –

Center –

Front Right –

Surr. Right –

Surr. Back Right –

Surr. Back Left –

Surr. Left –

Left Top Front/Middle/Back –

Right Top Front/Middle/Back –

Subwoofer –

As described in "essential setup" on page E-26, measure the distance from each loudspeaker in your system to your ear in the main listening position and enter the

values. This allows the Receiver to calculate the correct relative delay for each loudspeaker.

Speaker Levels





Calibration settings for the test noise signal level through the loudspeakers and measured at the listening position.

NOTE

Speakers that are not present in your configuration will be greyed out.

If Dirac Live for Lexicon is used, these settings will also be greyed out as they are autoselected by Dirac

These settings are applied to all audio inputs and are stored in memory and recalled each time the unit is powered up.

Use the  and  navigation buttons on the remote control to select the relevant speaker. Press  to enable/disable the calibration noise and the  and  navigation buttons to adjust the noise level from each speaker.

Front Left –

Center –

Front Right –

Surr. Right –

Surr. Back Right –

Surr. Back Left –

Surr. Left –

Left Top Front/Middle/Back –

Right Top Front/Middle/Back –

Subwoofer –

As described in “essential setup” on page E-26, adjust the level of the test noise from each speaker so that an SPL meter at the listening position measures 75dB SPL.

Video Inputs

Settings to optionally assign a video source to each of the normally audio-only inputs.

These settings are stored in memory and recalled each time the unit is powered up.

Video Input CD –

Video Input Aux –

Video Input FM –

Video Input USB –

Video Input Net –

Video Input DAB

The default for each of the audio inputs is ‘None’. You could, however, associate ‘Sat’ video with FM or Digital Radio audio to receive radio commentary of a sports game with pictures from satellite coverage, for example.

HDMI Settings

The settings in this menu control the output resolution from the video processor in the Receiver. These settings are applied to all video inputs and are stored in memory and recalled each time the unit is powered up.

HDMI1 OSD – Selects whether the main zone pop-up OSD messages are On or Off. It is stored in memory and recalled each time the unit is powered up.

- When **On**, all user adjustments that are made during the general use of the Receiver are displayed on screen as well as the front panel display. This includes the adjustment of volume, subwoofer level, lip sync, tone controls, etc. It is stored in memory and recalled each time the unit is powered up.

- When **Off**, the above user adjustments will not appear on screen, only on the front panel display. This leaves the picture on your display device clear of pop-up text. However, regardless of this setting the Setup menus are always displayed on screen.

HDMI Output 1080p – This setting controls the output resolution of the HDMI output when receiving 1080p input - bypass or upscale to 4k2k.

Lipsync – (Information only) Displays how much lip sync is automatically applied to the HDMI output to compensate for video processing delays in the attached display device. Not all display devices support this function.

Mode

Lists the decode and downmix options you wish to include when cycling through the options on the **MODE** button. Settings are Yes or No. The list is divided into two sections depending on the source audio type. See section “decoding modes” on page E-32 for more information on each processing and decoding mode.

These settings are applied to all audio inputs and are stored in memory and recalled each time the unit is powered up.

For Stereo sources:

Dolby Surround –

DTS Neural:X –

DTS Virtual:X –

Logic7 Immersion –

5/7 Ch Stereo –

The first section, ‘Stereo sources’ is the list of processing modes you wish to make available for stereo signals (analog stereo, digital PCM stereo, Dolby 2.0, DTS 2.0, etc). When a stereo signal is applied, each press of the **MODE** button cycles through the processing modes you have enabled in the ‘Stereo sources’ section. The unprocessed Stereo option is always available for stereo signals therefore it is not shown in the list.

For Multi-channel sources:

Stereo Downmix –

Dolby Surround –

DTS Neural:X –

DTS Virtual:X –

Logic7 Immersion –

The second section, ‘Multi-channel sources’ is the list of processing modes you wish to make available for multi-channel digital signals (any Dolby or DTS digital stream that has more channels than stereo 2.0). When a multi-channel digital signal is applied, each press of the **MODE** button cycles through the processing modes you have enabled in the ‘Multi-channel sources’ section.

Zone Settings

Lists the volume and control settings for Zone 2. These settings are applied to all audio inputs and are stored in memory and recalled each time the unit is powered up.

Z2 Input – Selects the analog audio and composite video source to be routed to Zone 2. The default is ‘Follow Z1’, i.e. the same source as currently selected in Zone 1.

Zone 2 Status – Selects if Zone 2 is in Standby or On.

Zone 2 Volume – The current volume in Zone 2.

Zone 2 Max. Vol – Limits the maximum volume setting the system can be turned up to in the Zone 2. This is a useful feature to prevent accidental overdriving of low power-handling speakers, for example.

Zone 2 Fixed Vol – The Zone 2 volume control can be locked at the current value for use with an external amplifier with its own volume control in Zone 2.

Zone 2 Max On Vol – Limits the maximum volume the system operates in the Zone 2 when it is switched on or comes out of Standby. The system comes on at this volume if the last used (possibly very loud) volume exceeds this value.

Network

The Receiver is fitted with a network audio client which is capable of playing internet radio stations as well as stored music on a network storage device such as a PC, or on a USB flash drive.

Use DHCP – Select if your network uses DHCP

- **No:** To assign a fixed IP address manually.

- **Yes:** To use network parameters given by the DHCP server.

IP Address – If not using DHCP, enter the IP address you have assigned to the Receiver for your network.

Subnet Mask – If not using DHCP, enter the subnet mask for the Receiver on your network.

Gateway – If not using DHCP, enter the IP address of the router the Receiver is connected to.

Primary DNS – If not using DHCP, enter the Primary DNS IP address of your internet service provider.

Alternate DNS – If not using DHCP, enter the Secondary DNS IP address of your internet service provider.

MAC address – (Information only) The unique address of the network card in your Receiver.

Friendly name – Allows you to rename the network “friendly name” of your Receiver.

decoding modes

Introduction

Your Receiver provides all the key decoding and processing modes for analog and digital signals, including the latest high definition audio formats over HDMI.

Modes for digital sources

Digital recordings are usually encoded to include information about their format type. The Receiver detects automatically the relevant format in a digital signal – such as Dolby Atmos, TrueHD, Dolby Digital Plus, DTS:X, DTS-HD Master Audio, Dolby Digital, or DTS – and switches to the appropriate decoding.

Modes for analog sources

Analog recordings do not contain information about their encoding formats, so the desired mode – such as Dolby Surround – needs to be selected manually.

Mode memory

Dolby Digital or DTS audio (including the high definition formats) can be output in two mix modes, selected using the **MODE** button:

- Surround (e.g., five main channels plus a subwoofer for a 5.1 source)
- Stereo downmix.

Two-channel audio, regardless of whether it is analog or digital can also be output in two mix modes, selected using the mode button:

- Surround (e.g., Dolby Surround, DTS Neural:X, etc.)
- Stereo.

The Receiver stores the settings for each source. Thus the decoding mode for the following groups of source material can be stored independently:

- Dolby Digital (multi-channel) and DTS source material
- Two channel Dolby, PCM or Analog source material

Two-channel source modes

The following decoding and surround modes are for creating multi-channel stereo modes from 2-channel

sources. They are available on the RV-6/RV-9/MC-10 for standard and high definition Dolby Digital 2.0, DTS 2.0, PCM or analog sources:

- Stereo** –
- 5/7 Channel Stereo** –
- Dolby Surround** –
- DTS Neural:X** –
- DTS Virtual:X** –
- Logic7 Immersion** –

Stereo

In this mode the RV-6/RV-9/MC-10 works as a conventional high quality audio amplifier. Note that if the subwoofer is enabled in stereo mode, then some processing of the signal is carried out.

- **Stereo Direct:** this achieves the best sound quality if an analog connection is present.
- **5/7 Channel Stereo:** this produces an output from all speakers by copying the left output to all left speakers and the right output to all right speakers. The center speaker outputs a mix of left and right.

Dolby Surround

Dolby Surround allows the RV-6/RV-9/MC-10 to derive up to 7.1.4 outputs from a two or multi-channel source to take better advantage of all amplifiers and speakers in your setup.

DTS Neural:X

DTS Neural:X is an advanced up-mixer that renders up to 7.1.4 channels of immersive audio from nearly any lower channel count content.

DTS Virtual:X

DTS Virtual:X creates an immersive audio experience by virtualising height content over traditional speaker configurations without the need for height speakers. Note - this mode is NOT available if height speakers are selected.

Logic7 Immersion

Harman proprietary Logic7 Immersion™ provides up to 12 channels of decoding and up to 7.1.4 outputs from two channel sources to encapsulate the listener with a rich and natural three dimensional sound.

Multi-channel source modes

Digital multi-channel source material is normally provided as '5.1 audio'. The '5.1 channels' comprise of: left, center and right front speakers, two surround speakers and a low frequency effects (LFE) channel. Since the LFE channel is not a full range channel, it is referred to as '.1'.

Surround systems decode and reproduce the 5.1 channels directly. The DTS-ES matrix enhanced decoding system creates one extra rear channel from information buried in the two surround signals of the 5.1 source. The ES enhanced system is sometimes referred to as a '6.1' system. This extra surround back channel is normally reproduced through two separate loudspeakers, creating a '7.1' system.

DTS-ES discrete is a true '6.1' source, with six discretely encoded channels, plus the '.1' LFE channel.

Dolby Digital Plus, Dolby TrueHD, Dolby Atmos, DTS:X and DTS-HD are high-resolution surround formats found on Blu-Ray discs

Decoding modes

The modes given in the following table are available for multi-channel digital sources.

Special modes such as DTS-ES 6.1 discrete, Dolby Digital Plus, Dolby TrueHD, Dolby Atmos, DTS:X, DTS-HD and IMAX® ENHANCED are only available from the correct source material.

High resolution audio sources	
Dolby Atmos	Dolby Atmos content is mixed as audio objects instead of traditional channels, so can take full advantage of the number and placement of your speakers.
Dolby TrueHD	Provides up to 7.1 full channels at 96kHz, 24bit resolution, with potentially no losses in the compression process. Data rates can be up to 18Mbps.
Dolby Digital Plus	Provides up to 7.1 discrete channels of audio with less compression than traditional Dolby Digital encoding. Data rates can be up to 6Mbps.
DTS-HD Master Audio	Provides up to 7.1 full channels at 96kHz, 24bit resolution, with potentially no losses in the compression process. Data rates can be up to 24.5Mbps.
DTS:X*	<p>DTS:X is a decoder package that renders immersive content which has been encoded with DTS:X encoding. DTS:X content consists of audio objects or a combination of audio channels and objects. The DTS:X decoder package also plays back legacy DTS formats including DTS-HD Master Audio lossless and lossy streams.</p> <ul style="list-style-type: none"> • Supports greater than 7.1 channel output configurations (including height speakers) • Provides "Dialogue Control" so consumers can adjust the sound to their preference or the listening environment • Remaps any DTS content to any speaker layout • Supports Blu-ray Disc (BD), DVD and streaming media formats, and legacy streams up to 192kHz. • Includes Neural:X, the latest upmixing/downmixing technology from DTS.
IMAX ENHANCED	IMAX ENHANCED content has been digitally remastered by IMAX to deliver the clearest picture quality with immersive sound. For more information, please visit www.IMAXenhanced.com .
For Dolby Digital sources	
Dolby Digital 5.1	Dolby Digital 5.1 sources deliver sound with five discrete full-range channels; left, center, right, surround left, surround right, plus LFE channel.
Dolby Digital Stereo Downmix	Provides a stereo downmix of the source material for use with headphones.
Dolby Digital 5.1 + Dolby Surround	This mode is used to derive information for the individual surround back channels from the surround channels, using the Dolby Surround decoder.
For DTS sources	
DTS 5.1	Less common than the Dolby Digital format, but generally recognised within the audio industry as being of superior sound quality. DTS 5.1 delivers surround sound with five full range channels plus an LFE channel.
DTS 5.1 Stereo Downmix	Provides a stereo downmix of the source material for use with headphones.
DTS-ES 6.1 Matrix	This is a 6.1 channel format based on DTS 5.1. It has the sixth channel matrix encoded into the surround left and surround right channels. The sixth channel is a surround center channel and is directed to the surround back left and surround back right speakers.
DTS-ES 6.1 Discrete	This is a true discrete 6.1 channel sound format. DTS-ES discrete mode operates only on sources with DTS-ES 6.1 discrete audio encoding.
DTS96/24	Provides up to 5.1 channels of audio at 96kHz, 24bit resolution for superior sound quality compared to standard DTS 5.1

Dolby volume



Dolby Volume is a sophisticated new technology that resolves the problem of different volume levels

between programme content (e.g. a TV show and advert breaks) and between sources (e.g. a rock radio station and DVD, or between two TV stations). It lets the listener enjoy everything at the same preferred listening level without having to reach for the volume control to compensate for the different recording/output levels. This is the Volume Leveller function of Dolby Volume.

Dolby Volume also works in conjunction with the Receiver volume control setting to compensate for the ear's changing sensitivity at different frequencies depending on how loud the audio is. It is based on a model of how human hearing works. It properly balances low, mid and high frequencies to maintain all the nuances and impact of the original audio regardless of the actual selected playback volume level. This is the Volume Modeller function of Dolby Volume.

Dolby Volume measures, analyses and maintains volume levels based on how people perceive sound. A variety of audio parameters are monitored including spectral- and time-based loudness to ensure that perceived dynamics, timbre and bass performance remain consistent at all volume levels.

Dolby Volume also lets the listener control a programme's dynamic range – the range between loud and quiet sounds. For example, with the volume turned down for late-night viewing, dynamic range can be adjusted so that speech remains clear and loud effects or music passages retain their impact without waking up the family.

Settings

Dolby Volume can be applied to any analog or digital stereo source or any digital multi-channel source. *It is not available in Stereo Direct or on the analog multi-channel input.* Dolby Volume can even be applied to processing of stereo signals (e.g. Dolby Surround) or when down-mixing a digital multi-channel source (e.g. Dolby Digital 5.1 down to stereo).

Dolby Volume can be enabled and configured separately for each audio input in the Input Config menu. The default is 'Off' for 'audiophile' listening. You may wish to turn Dolby Volume 'On' for TV and movie sources to maintain the same perceived overall listening level

between sources and frequency response regardless of the volume setting. Most of the controlling parameters of Dolby Volume are automatic as they are dependent on analysis of the audio signal and the volume setting of the Receiver. However, the Volume Leveller and Calibration Offset controls (see below) can be adjusted to your preference.

Volume Leveller

The Volume Leveller function of Dolby Volume controls how closely quiet and loud sources and programme content are matched to each other, based on the ear's perception of loudness. The range of values is 0 (minimal levelling) to 10 (maximum levelling). The default setting is 2. If the Volume Leveller function is turned off, no level matching between sources and programme material is performed. This is not the same as turning Dolby Volume off as volume related frequency response processing is still active.

When Dolby Volume is being applied to the current input, a Dolby Volume processing mode indicator is shown on the OSD and the front panel display.

Calibration Offset

The Calibration Offset parameter of Dolby Volume allows you to compensate for speaker efficiencies and listening position – effectively moving the reference listening level up or down the volume scale. The default value is 0 and this should normally produce a good result when the Receiver speaker levels are set using a sound pressure level meter at the listening position (75dB SPL, 'C' weighting, slow response).

Dolby atmos



Dolby Atmos® for the home represents every

sound in the original cinema mix as an audio object. Extensions to the Dolby Audio™ CODECs, along with an advanced scalable algorithm, allow Dolby Atmos to be delivered via Blu-ray Disc and streaming media. Your Dolby Atmos equipped RV-6/RV-9/MC-10 adapts the cinema experience to your home theatre using up to 12 channels (for configurations above 8 channels, additional power amplification is required), recreating the original artistic concept.

Dolby Atmos speaker setup

With Dolby Atmos technology, you have two basic options for overhead sound:

- Ceiling speakers
- Dolby Atmos enabled speakers

The RV-6/RV-9/MC-10 supports up to four ceiling or Dolby Atmos enabled speakers. If just two are used then they should be positioned centrally between the screen and listening position, if four are used then they could be positioned just in front of the screen and just in front of the listening position. For a 5.1.2 configuration, channels 6&7 of the RV-6/RV-9/MC-10 can be configured for the height 1 channels.

Dolby Atmos enabled speakers

Dolby Atmos enabled speakers are specially engineered to direct sound upward, where it reflects off the ceiling to produce an incredibly lifelike re-creation of overhead sound. Dolby Atmos enabled speakers come in two versions:

- Integrated units that also include traditional forward firing speakers.
- Add-on modules, containing only the upward-firing elements, that you put on top of your current speakers or on a nearby surface.

Ceiling speakers

Ceiling speakers are mounted directly in the ceiling as shown in this 7.1.4 example.



tuner operation

The Receiver is fitted with a FM & DAB (digital radio) tuners. DAB broadcasts are not available in all locations. This section deals with tuner operation, for information on setting up the tuner and installing aerials, see page E-13.

When a tuner input is selected, the OSD shows a list of radio presets plus an information panel giving all available information about the current frequency (for FM) or station (for DAB).

The front panel will also give the same information, pressing the **INFO** key will cycle through the various items of information:

FM

- Processing mode (default)
- Radiotext (if available)
- Programme type (if available)
- Signal strength



DAB

- Processing mode (default)
- Radiotext (if available)
- Programme type
- Signal quality
- Bit-rate of transmission

Tuning/Channel Selection

When switching to the internal **TUNER** source, the Receiver enters the last used tuner band, be it FM or DAB. Repeatedly pressing **RADIO** cycles through the available tuner bands on your Receiver.

FM analog radio

Frequency tuning on FM radio is done using the  and  buttons on the remote control in **TUN** device mode. Individual presses move the frequency down and up one step. If you press and hold either of the tuning buttons for two seconds, the tuner scans to the next strong signal. You can stop a scan at any time by pressing one of the tuning buttons again.





In Europe, the internal FM radio is capable of receiving RDS (Radio Data System) radiotext signals that are transmitted on some stations. The RDS information typically includes the radio station name, the music or speech genre as well as additional information related to the current programme. On music stations this is often information on the currently playing track.

DAB digital radio

Digital Audio Broadcasting (DAB) radio is becoming more widely available. See www.worlddab.org/country_information for information on DAB availability.

You will need to scan for available stations before being able to listen to them.



To scan for DAB stations, first select the DAB tuner then press and hold  until the display indicates scanning has started. The Receiver will then scan all the DAB radio frequencies and compile a list of the stations that are available.



When the scan is complete, you can scroll through the station list using the  and  buttons on the remote control. To listen to the currently displayed station press the . If you do not press  within two seconds, the display will revert to displaying the currently playing station.

Internet radio



Please see the Network/USB Operation section on page E-36 for details of internet radio operation.

Saving and selecting Presets

Preset selection uses the  and  keys on the remote to browse and  to select the preset when the remote is in **TUN** device mode.

Up to 50 presets can be stored and these can be from any band, for example Preset 1 could be an FM station, preset two a DAB station, etc. Pressing the **OK** key causes the next available preset number to be displayed, then pressing the **OK** key again stores the current frequency/channel in that preset. If a different preset number is required, press the  and  keys until the desired number is displayed before pressing the **OK** key for a second time.

Deleting Presets

When in tuner browse mode (using  and  to scroll through the presets), the yellow button on the remote is used to delete the currently highlighted (but not playing) station or frequency.

network/usb operation

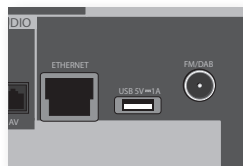

The Receiver is fitted with a network audio client which is capable of playing internet radio stations as well as stored music on a network storage device such as a PC, or from a USB flash drive.

For information on installing the Receiver on your network see page E-14.

The Receiver supports the following file formats:

- MP3
- WMA (Windows™ Media Audio)
- WAV
- FLAC (Free Lossless Audio CODEC)
- MPEG-4 AAC (iTunes™) with DRM10 support

Favorites

You can store internet radio stations in your 'favourites' folder for easy access later. Once playing, pressing the RED key adds the station to the 'favourites' folder. Pressing GREEN removes the station from the 'favourites' folder (this key only has an effect if the station is in the favorites folder).

NOTE

For playback from a network device, the network device needs to be running a universal plug and play (UPnP) service, such as Windows Media Player 11™. This can be downloaded free of charge from www.microsoft.com or installed via the Windows update installer. Windows 7™ and Vista™ have this functionality built in. Windows Media Player requires music library sharing/streaming to be enabled in order to serve music to the Receiver.

Other free and paid-for UPnP services are available for other computer operating systems. Some network attached storage (NAS) systems include a built-in version of a UPnP service.

Selecting the playback source

Selecting the network client will allow playback of internet radio stations and stored music on a networked storage device or USB memory device.

To select the network source just press NET on the remote. You can also cycle to it using the -INPUT/INPUT+ keys on the front panel.

The 'home' page has options for playing audio from a USB device, Internet Radio or from your home network using the 'Music Player' option. Navigate through these items using the ▲, ▼, ◀ and ▶ keys. Folders that may contain playable files have a 📁 symbol, playable files have a 🎵 symbol. Once you reach the track you wish to play, press OK.

Once playing, pressing || will pause the track (except Internet Radio).

Pressing the ► key skips forward one track. If the last track is reached the key is ignored.

Pressing the ◀ key skips back one track. If the first track is reached, the key is ignored.

USB playback

Insert a USB device into the socket on the Receiver and select the network client input. The USB device appears in the list of folders that can be navigated. Highlight it using the ▲ and ▼ keys and press ▶ to navigate the contents of the USB device. Navigate through folders 📁 (using the ▲, ▼, ◀ and ▶ keys) to a music file 🎵 and press OK to play the file.

Internet radio stations

Although you can manually browse for an internet radio station, the Receiver uses the vTuner service to allow easy selection of favourite internet radio stations and podcasts. To set up this service for your Receiver, please visit www.lexiconradio.com

There, you will be asked to enter the Media Access Controller (MAC) address which is the unique ID of your Receiver. This MAC address can be found in the network section of the setup menu.

Once you have entered the MAC address, you can then browse stations and podcasts and set up groups of favourite stations. When you next connect your Receiver to the internet, these groups will appear in the 'My favourites' folder.

Pressing the INFO key will cycle what is shown on the lower portion of the front panel display between:

- Elapsed Time (default)
- Processing mode
- Album (if available)
- Artist (if available)
- File information (bitrate, type).

Listen out loud with Spotify Connect

1. Connect your Lexicon AVR to your wifi network
2. Open up the Spotify app on your phone, tablet or laptop using the same wifi network
3. Play a song and select Devices Available.
4. Select your Lexicon AVR and start listening.

Licenses

The Spotify software is subject to third party licenses found here:

<https://developer.spotify.com/esdk-third-party-licenses>

multi-room set up

The Receiver allows independent routing to a separate set of equipment, typically used for a second living space, e.g., bedroom or lounge.

Zone 2

Audio outputs



The **Z2 OUT, R** and **L** phono sockets should be connected to the analog audio inputs (Usually labelled **ANALOG AUDIO IN**) of the Zone 2 display device, or to the inputs of an additional stereo power amplifier in Zone 2 (for example, the Lexicon P38).

Speaker outputs

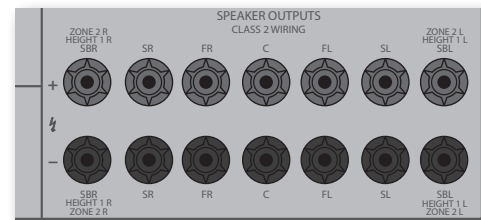

If the main zone has a 5.1-channel surround sound speaker system (not a 7.1-channel system), the spare SBL and SBR speaker outputs can be used to power speakers in Zone 2, so that a power amplifier is not required.

To configure the outputs, navigate to the 'Spkr Types' option in the Setup Menu and set the option 'Use Channels 6+7 for' to 'Zone 2'; see page E-26.

Zone 2 control connections

The Receiver also allows remote control from Zone 2.



Z2 IR

This allows the Receiver to be controlled remotely from Zone 2 via Infra-red remote control. Connect a remote IR receiver in Zone 2 to allow control of the Receiver from this listening/viewing area.

For more information on remote IR receivers, see "Z2 IR" on page E-14.

TRIG Z2

This allows the Receiver to remotely switch on devices in Zone 2 when Zone 2 is selected. For example you could set your television in Zone 2 to switch on when 'Zone 2' is selected on Receiver.

For more information on triggers, see "Trigger connectors" on page E-14.

Please note that not all AV devices have this feature, nor are triggers essential for listening and viewing in a separate zone.

customising the remote

Code learning

The supplied remote comes with a complete library of pre-programmed codes. After you have set up the remote for your device, you may find that there are one or more functions on your original remote which do not have a place on the keypad. For convenience, the remote offers a Code Learning feature that allows you to copy up to 16 functions from an original remote control onto the remote keypad.

Before you start, make sure that:

- The original remote control is working correctly.
- The remotes are not pointing at your device.
- The remotes have fresh batteries.
- The remotes are not in direct sunlight or under strong fluorescent lights.

NOTE

Learned functions are mode-dependent. You could assign up to eight different functions to a single key – a separate learned function for each mode.

Direct code setup (Method 1)

The first method is to program the remote with the 3-digit code number for the device you wish to control – see “device code tables”. Make a note of the suggested number or numbers – the most popular code is listed first. Now power on the device.





1. Press the Device key for the product you want to set up, together with the 1 key. Hold down both buttons for three seconds until the LED stays lit.
You are now in setup mode, and you can release the buttons.
2. Enter a 3-digit code for the device.
If the 3-digit code number you entered is correct for the device, it will turn off. If it doesn't turn off, enter the next code number from your list until the device does turn off.
3. Once you have found the correct code, press the Device key again. The LED blinks three times  to confirm that the code has been successfully stored.

NOTE

On the following pages, a single ‘blink’ of the remote's power LED is indicated by the symbol .



Library search setup (Method 2)

Library search allows you to scan through all the codes contained in the remote's memory. It can take a lot longer than the previous method, so only use this method if:

- Your device does not respond to the remote after you have tried all the codes listed for your brand.
 - Your brand is not listed at all in the Device Code tables.
1. Press the Device key for the product you want to set up, together with the 1 key. Hold down both buttons for three seconds until the LED stays lit.
 2. Point the remote control at the product you wish to control and press the  or  button on the navigation pad. Each time the  or  button is pressed, the code counts up (or down) one code number with a signal to power off the device.
 3. Continue pressing the up or down button, in approximately one second intervals, until the device turns off. (DO NOT alternate the up and down button – you need to move in only one direction.)
 4. To store the correct code, press the Device key again. The LED blinks three times  to confirm that the code has been successfully stored.

Learning setup (Method 3)

The third method involves ‘teaching’ the Lexicon remote from the original remote for the device. The two remotes should be facing each other, about 10cm apart.

1. Press the Device key for the product you want to set up, together with the 3 key. Hold down both buttons for three seconds until the LED stays lit.
2. Press the button on the Lexicon remote that you want to assign a command to. The LED blinks once  indicating that the remote is ready to learn the command.
3. Press and hold the appropriate key on the other remote until the LED blinks twice . This indicates the Lexicon remote has learned the command from your other remote.
4. Continue learning the commands from your other remote by pressing the next button on the remote and repeating steps 2 and 3.
5. Once the remote has learned all the selected commands, press and hold the Device key you used to enter learning together with the Numeric 3 key to store the learned commands.

NOTE

If the Lexicon remote LED blinks five times , there was an error in the learning process. In this case, please start the Learning Setup from the start.





The AMP and RADIO keys do not learn commands.

Important notes



- Once you start a Code Learning session, you have approximately ten seconds to conduct each step. Any longer, and a timeout means that you'll have to start the process again.
- The Learning feature is mode-specific – you can copy one feature *per mode* onto a key.
- The remote can learn approximately 16 functions in total.
- To replace a learned function, simply assign a new function to the same key.
- Learned functions are retained when you change batteries.
- If Code Learning fails, try altering the distance between the two remotes; make sure that the ambient light is not too bright.

Deleting the learned data





To delete all the learned data for a device:

1. Press the Device key for the product you want to set up, together with the 3 key. Hold down both buttons for three seconds until the LED stays lit.
2. Press and hold down the Device key for the product that you want to erase, together with the  key for three seconds until the LED blinks twice .
3. If any further key press is not made for 30 seconds after the LED blinks twice , the remote leaves erase mode without deleting the learned data.
4. If you press the Device key one more time within 30 seconds after LED blinks twice , you can finish the erase mode deleting all the data learned on the Device. The LED blinks three times  to confirm.

To delete the learned data for a key for a device:

1. Press the Device key for the product you want to set up, together with the **3** key. Hold down both buttons for three seconds until the LED stays lit.
2. Press and hold down the key on which you want to delete the data for three seconds. The LED blinks twice . If any further key press is made, the remote escapes from erase mode without deleting the learned data.
3. If any further key press is not made for 30 seconds, the LED blinks twice , the remote get out of the erase mode automatically without deleting the learned data.
4. If you press the Device key together with the **3** key again within 30 seconds after the LED blinks twice, all the data learned for that Device is deleted and you leave erase mode. The LED blinks three times  in confirmation.

Reading stored code numbers

1. Press the Device key for the product that you want to set up together with the **4** key. Hold down both keys for three seconds until the LED blinks.
2. Press the **INFO** key and count the number of blinks (=1, =2, =3, etc.). There is a time gap between digits. (Note that '0' is represented by ten blinks: .)

Locking/Unlocking a specific Device Mode

When you first unpack your remote and insert the batteries, it is able to control certain Lexicon components automatically (e.g. BD players, Amplifiers, Tuners and CD Players). We achieve this by programming specific Lexicon device codes onto the relevant Device Mode keys, then locking the Device Modes so you don't reprogram them inadvertently.

If you want to override these locked default settings – to control a third-party BD player, for example – you will first need to unlock BD Mode before setting up the remote using one of the learning methods described on the previous page.

Here are the factory default settings:

Device Mode	Default status	Default codes
AMP	Locked	001 (Lexicon code 16)
BD	Locked	001 (Lexicon)
AV	Unlocked	108 (Philips TV)
VCR	Unlocked	Code learning only
GAME	Unlocked	Code learning only
STB	Unlocked	030 (Bush/Goodmans/Grundig, from SAT database)
SAT	Unlocked	128 (Sky+ Digital, from SAT database)
PVR	Unlocked	018 (Humax PVR, from SAT database)
CD	Locked	001 (Lexicon)

Alternative codes are available for multi-room solutions, or in the case of code clashes with other manufacturer's products.



For example:

AMP (system code 19): 002

Note that you need to change the system code on the product you wish to control, as well as the remote.

1. **AMP**, **BD**, **CD** and **TUN** are the Device keys that may be Locked or Unlocked.
Lock and Unlock are toggles (they change from Lock to Unlock to Lock, etc.).
2. Press and hold the Device and **6** keys together for three seconds.

The power LED stays lit, showing that it is in Lock/Unlock setup mode.

3. If there is no further key input for 30 seconds, the LED goes off and the remote leaves Lock/Unlock setup mode.
4. To verify the status of a device, press the **3 6 9** keys in sequence:
If Lock is set, the LED blinks three times: .
If Unlock is set, the LED blinks five times: .
5. If you press a valid Device key within 30 seconds, the LED blinks three times:  and the remote leaves Lock/Unlock setup mode.

Controlling the volume of other devices

By default, the volume keys and mute key control the amplifier volume.







You can configure these buttons so they send volume commands to another device. In the following example, the volume commands are sent to a linked AV device (your television, for instance):

1. Press **AV + 5** for three seconds, until the LED lights and stays on.
2. Press **VOL UP**.
3. Press **AV** again. The LED blinks three times .

The volume and mute keys will now send the volume commands to the TV.

To set the volume buttons to control the amplifier once more, repeat the above steps, except press **AMP** in step 3.

Hidden commands



Command	Effect
AMP + 	Sends a Power On command
AMP + 	Sends a Power Off command
AMP + OK	Sends a Zone command
AMP + 	Sends a Resolution command
CD + 	Sends a Power On command
CD + 	Sends a Power Off command
BD + 	Sends a Power On command
BD + 	Sends a Power Off command

BD + 

Sends a Resolution command

Factory default reset

You can reset your remote to the original factory default settings.

Press and hold both the  (home) and **MENU** keys for about five seconds until the power LED blinks five times .

All programming and setup codes that you have entered into the remote are erased and the remote returns to the original factory default settings.

Device codes

The tables that begin on page 49 (in the final section of this Handbook) list 3-figure codes for different manufacturers' devices.

Use these when setting your remote up to control your devices, as described in Direct code setup: Method 1 (see previous page).

If more than one code number is listed, try the first number. If the results are unsatisfactory, continue trying the numbers for that manufacturer to get the best 'fit' with the functionality required.

If the manufacturer of your equipment is not listed, you can try Library search setup: Method 2 (see previous page). This method allows you to scan through every code contained in the remote's memory.

trouble- shooting

Problem	Check that...
There are no lights on the unit	<ul style="list-style-type: none"> ■ the power cord is plugged into the Receiver and the mains socket it is plugged into is switched on. ■ the power button is pressed in. <p>If a red LED is present, the Receiver is in standby mode. Press any button on the front panel or remote control.</p>
The unit responds erratically or not at all to the remote control	<ul style="list-style-type: none"> ■ there are fresh batteries in the remote control. ■ the front panel window is visible and you are pointing the remote control towards it.
The front panel display is blank	<ul style="list-style-type: none"> ■ the display hasn't been turned off. Press the DISPLAY button on the front panel or remote control.
No picture is being produced	<ul style="list-style-type: none"> ■ your viewing device is turned on and switched to display your Receiver. Test by pressing the MENU button on the Receiver or on the remote and look for the main menu screen on your display device. ■ the correct video input is selected on the Receiver. ■ the video source is on, is operating normally, and is in 'play' mode if appropriate.
There are bright edges or 'ghosts' on the picture	<ul style="list-style-type: none"> ■ ensure the 'sharpness' control on your display device is switched off or set to near minimum. ■ for HDMI connections, try using a shorter cable or alternatively a different brand.
No sound is produced	<ul style="list-style-type: none"> ■ the correct input has been selected. ■ the 'Audio Source' has been set correctly in the 'Input Config.' menu ■ the source equipment is on, is operating normally and is in 'play' mode if appropriate. ■ the volume is turned up to a reasonable level and the Receiver is not in mute mode.
The sound is poor or distorted	<ul style="list-style-type: none"> ■ you have not excessively increased the input sensitivity (i.e. reduced the maximum input signal voltage) in the Input Config. menu if an analog input is being used. ■ you have selected the correct size of speakers to suit your system in the setup menu.

Problem	Check that...
Sound only comes from some of the speakers	<ul style="list-style-type: none"> ■ you have an appropriate surround source selected and playing. ■ the BD/DVD disc is encoded in the appropriate format, and the correct format has been selected in the disc start menu of the BD player (if applicable). ■ the BD/DVD player has been set to output 'bitstream' audio on the digital output. ■ the display window indicates that the disc you are playing is a multichannel recording (you may need to press the INFO key several times until you get to the 'incoming format' display). ■ all the speakers are correctly connected to the speaker terminals and are secure. ■ you have not selected 'Stereo' as the decoding mode. ■ your speaker balance is correct. ■ you have configured the Receiver to include all the speakers in your system.
Unable to select Dolby or DTS decoding modes	<p>The Receiver can only apply Dolby and DTS decoding to sources which have been encoded in the same format.</p> <p>Check that:</p> <ul style="list-style-type: none"> ■ digital source is selected and connected. ■ the source is playing appropriately encoded material. ■ the BD/DVD disc is encoded in the appropriate format and that the correct format has been selected in the disc start menu of the BD player (if applicable). ■ the BD/DVD player has been set to output 'bitstream' audio on the digital output.
When playing a Dolby BD/DVD, the MC-10/RV-9/RV-6 selects Dolby Surround	<ul style="list-style-type: none"> ■ you have a digital connection from your BD/DVD player. ■ sometimes Dolby BD/DVD discs contain material at either the beginning or the end of the main movie that is not in full 5.1 format, but in two-channel.
Hum on the analog input	<ul style="list-style-type: none"> ■ all cables are making a good connection. If necessary withdraw the cable from the connector and plug it fully in again (turn the power off before doing this). ■ the connections inside the source cable connector are not broken or badly soldered. ■ if the hum originates only when one particular source component is connected, that an aerial cable, or dish connection to this source is ground isolated. Contact your installation contractor.
There is radio or television reception interference	<ul style="list-style-type: none"> ■ where the interference is coming from. Switch off each source component in turn, then any other equipment. Most electronic equipment does generate low levels of interference. ■ try re-arranging cabling from the nuisance source away from other cabling. ■ ensure that the cabling used is high quality, specified for its purpose, and is properly screened. ■ if the problem persists, contact your dealer.

Problem	Check that...
The source switching changes randomly or freezes on one source	<ul style="list-style-type: none"> ■ there are no static or impulse interference problems caused by nearby power equipment switching, e.g., heating or air conditioning control. Switch the Receiver off, wait ten seconds, then switch it on again to clear an operating problem. Contact your installer if the problem returns or persists. ■ there is no direct sunlight shining on the infra-red detector behind the front panel display.
Volume is always too loud when I turn on	<ul style="list-style-type: none"> ■ the 'max on volume' setting is not set too high.
When a USB memory device is connected, 'USB' is not shown in the network client's list of folders	<ul style="list-style-type: none"> ■ a USB memory device is connected that conforms to the mass storage class. ■ a USB hub is not being used.
If files on a USB memory device cannot be played:	<ul style="list-style-type: none"> ■ the USB device is formatted in FAT16 or FAT32. ■ the USB device does not have multiple partitions. ■ the files are in a compatible format.
If files on a computer cannot be played	<ul style="list-style-type: none"> ■ the files are in a compatible format. ■ the computer is connected via a network and not USB – the Receiver USB port cannot be used for a direct connection to a computer
If you cannot connect to a wired network	<ul style="list-style-type: none"> ■ the Ethernet cable you are using is correctly connected between the Receiver and the network hardware. ■ the network is set up for fixed IP addressing and you have the Receiver set to use DHCP. ■ the network is set up for DHCP and you have the Receiver set to use fixed IP addressing.
If you cannot connect to a favourite internet radio station	<ul style="list-style-type: none"> ■ the station is still broadcasting or is not congested – try again later.
If the internet radio station sound quality is poor or broken	<ul style="list-style-type: none"> ■ the radio station does not have a low bit rate (use the INFO key to find this or look on the OSD). ■ the network is not slow or congested.

specifications

MC-10

Stereo line inputs	
Maximum input	4.5V rms
Nominal sensitivity	1V, 2V, 4V (user adjustable)
Input impedance	47k Ω
Signal/noise ratio (A-wtd ref 100W) normal/stereo direct	100dB/120dB
Frequency response	20Hz—20kHz \pm 0.1dB
Preamplifier outputs	
Nominal output level	1V RMS
Output impedance	560 Ω
THD+N (20Hz—20kHz)	-100dB
Headphone output	
Maximum output level into 32 Ω	2Vrms
Output impedance	<5 Ω
General	
Mains voltage	110–120V or 220–240V, 50–60Hz
Power consumption (maximum)	50W (Thermal dissipation approx. 170 BTU/hour)
Power consumption (idle, typical)	50W (Thermal dissipation approx. 170 BTU/hour)
Power consumption (standby)	<0.5W
Dimensions	433 x 425 x 171mm
W x D (including speaker terminals) x H (including feet)	
Weight (net)	10.25kg
Weight (packed)	14.25kg
Supplied accessories	Mains lead Remote control 2 x AAA batteries Manual DAB/FM aerial Calibration microphone USB sound card
E&OE	
NOTE: All specification values are typical unless otherwise stated.	

Continual improvement policy

Lexicon has a policy of continual improvement for its products. This means that designs and specifications are subject to change without notice.

RV-9

Continuous power output, per channel, 8Ω/4Ω	
2 channels driven, 20Hz - 20kHz, <0.02% THD	120W/200W
2 channels driven, 1kHz, 0.2% THD	130W/210W
7 channels driven, 1kHz, 0.2% THD	100W/180W
Residual noise & hum (A-wtd)	<0.15mV
Stereo line inputs	
Maximum input	4.5V rms
Nominal sensitivity	1V, 2V, 4V (user adjustable)
Input impedance	47kΩ
Signal/noise ratio (A-wtd ref 100W) normal/stereo direct	100dB/120dB
Frequency response	20Hz—20kHz ± 0.1dB
Preamplifier outputs	
Nominal output level	1V RMS
Output impedance	560Ω
THD+N (20Hz—20kHz)	-100dB
Headphone output	
Maximum output level into 32Ω	2Vrms
Output impedance	<5Ω
General	
Mains voltage	110–120V or 220–240V, 50–60Hz
Power consumption (maximum)	1.5kW (Thermal dissipation approx. 5200 BTU/hour)
Power consumption (idle, typical)	100W (Thermal dissipation approx. 340 BTU/hour)
Power consumption (standby)	<0.5W
Dimensions	433 x 425 x 171mm
W x D (including speaker terminals) x H (including feet)	
Weight (net)	16.7kg
Weight (packed)	20.0kg
Supplied accessories	Mains lead Remote control 2 x AAA batteries Manual DAB/FM aerial Calibration microphone USB sound card
E&OE	
NOTE: All specification values are typical unless otherwise stated.	

RV-6

Continuous power output, per channel, 8Ω	
2 channels driven, 20Hz - 20kHz, <0.02% THD	110W
2 channels driven, 1kHz, 0.2% THD	125W
7 channels driven, 1kHz, 0.2% THD	90W
Residual noise & hum (A-wtd)	<0.15mV
Stereo line inputs	
Maximum input	4.5V rms
Nominal sensitivity	1V, 2V, 4V (user adjustable)
Input impedance	47kΩ
Signal/noise ratio (A-wtd ref 100W) normal/stereo direct	100dB/110dB
Frequency response	20Hz—20kHz ± 0.2dB
Preamplifier outputs	
Nominal output level	1V RMS
Output impedance	560Ω
THD+N (20Hz—20kHz)	-100dB
Headphone output	
Maximum output level into 32Ω	2Vrms
Output impedance	<5Ω
General	
Mains voltage	110–120V or 220–240V, 50–60Hz
Power consumption (maximum)	1.5kW (Thermal dissipation approx. 5200 BTU/hour)
Power consumption (idle, typical)	100W (Thermal dissipation approx. 340 BTU/hour)
Power consumption (standby)	<0.5W
Dimensions	433 x 425 x 171mm
W x D (including speaker terminals) x H (including feet)	
Weight (net)	15.5kg
Weight (packed)	18.8kg
Supplied accessories	Mains lead Remote control 2 x AAA batteries Manual DAB/FM aerial Calibration microphone USB sound card
E&OE	
NOTE: All specification values are typical unless otherwise stated.	

product guarantee

Worldwide Guarantee

Limited warranty

Lexicon products are warranted against defects. The duration of a warranty depends on the laws in the country in which it was purchased.

Your local Lexicon retailer can help you determine the duration and coverage of your warranty.

For more information please visit: LEXICON.COM

Please visit LEXICON.COM for additional language support on the user manual.

Veillez visiter LEXICON.COM pour obtenir le mode d'emploi en d'autres langues.

Para obter o manual do usuário em outros idiomas, acesse LEXICON.COM

Ga naar LEXICON.COM voor de handleiding in andere talen.

Gå til LEXICON.COM for bruksanvisning på flere språk.

Если вам требуется дополнительные версии руководства пользователя на других языках, посетите сайт LEXICON.COM.

別の言語に対応したユーザーマニュアルを読むには、LEXICON.COMにアクセスしてください。

사용자 설명서에 대한 추가 언어 지원은 LEXICON.COM에서 확인하십시오

请访问 LEXICON.COM 以获取其他语言版本的用户手册。

Visita LEXICON.COM para obtener el manual de usuario de soporte en idiomas adicionales.

Weitere Sprachfassungen der Bedienungsanleitung findest Du unter LEXICON.COM.

Si prega di visitare LEXICON.COM per i manuali di istruzioni in altre lingue.

Jos tarvitet ylimääräistä kieleen liittyvää tukea käyttöohjeesta, käy osoitteessa LEXICON.COM.

Gå ind på LEXICON.COM for at se betjeningsvejledningen på flere sprog.

Gå till LEXICON.COM för mer information om språk i användarmanualen.

Торговая марка: Lexicon

Назначение товара: Пассивная акустическая система

Изготовитель: Харман Интернешнл Индастриз Инкорпорейтед, США, 06901

Коннектикут, г.Стэмфорд, Атлантик Стрит 400, офис 1500

Страна происхождения: Китай

Импортер в Россию: ООО Внешторг-Юг, Россия, 171640, Тверская область, г.Кашин, ул.

Карла Маркса, д.57А

Гарантийный период: 1 год

Информация о сервисных центрах: <http://absolut-audio.ru/Servis/> тел. +7 (495) 995-10-80

Срок службы: 5 лет

Номер документа соответствия: Товар не подлежит обязательной сертификации

Дата производства: Дата изготовления устройства определяется по двум буквенным

обозначениям из второй группы символов серийного номера

изделия, следующих после разделительного знака «-». Кодировка

соответствует порядку букв латинского алфавита, начиная с января

2010 года: 000000-МУ0000000, где «М» - месяц производства

(А - январь, В - февраль, С - март и т.д.) и «У» - год производства (А - 2010, В - 2011, С - 2012 и т.д.).

HARMAN International, Incorporated
8500 Balboa Boulevard, Northridge, CA 91329 USA

© 2017 HARMAN International, Incorporated. All rights reserved.

Lexicon and the Lexicon logo are trademarks of HARMAN International Industries, Incorporated, registered in the United States and/or other countries.

Features, specifications and appearance are subject to change without notice.

For questions, assistance or additional information concerning any of our products, call us at: 1 (877)691-4171. For technical support, submit your detailed inquiry

Claims under guarantee

This equipment should be packed in the original packing and returned to the dealer **from whom it was purchased**. It should be sent carriage prepaid by a reputable carrier – **not** by post. No responsibility can be accepted for the unit whilst in transit to the dealer or distributor and customers are therefore advised to insure the unit against loss or damage whilst in transit.

For further details contact Lexicon at csupport@harman.com

Problems?

If your Lexicon dealer is unable to answer any query regarding this or any other Lexicon product please contact Lexicon Customer Support at the above address and we will do our best to help you.

On-line registration

You can register your product on-line at www.lexicon.com.

device code tables

Amplifier

Adc	007
Adcom	082 092 225 161 269 356
Aiwa	170 018 104 202 203 213 211 188
Akai	189
Amc	125 126 127 281 282
Angstrom	142
Anthem	335 337
Arcam	001 002 141 418
Atlantic Technology	342
Audio File	071
Audio Matrix	167
Audio Technica	134
B & K	096 097
Bose	070 170 224 347 409 460 903 906
Boston Acoustics	447
Brix	555
Bryston	023
Cambridge Audio	522 523 525 630 683 684 552
Carver	006 028 061 071 201 214 226 185 022 077 284
Cinema Sound	134
Citation	148 272
Clarion	026
Classe	537 410 411
Delphi	515
Denon	109 215 230 234 330 801
Dvico	802
Elan	057 290
Enlightened Audio	099 098
Escient	368 451
Fisher	047 214 182 297
Flextronics	378
Fosgate Audionics	231 342
GE	056
Goldstar	008
Harman Kardon	231 233 153 154 118 318
Hitachi	020
Integra	275 781
Jamo	398
Jcpenney	216
Jensen	058
JVC	163 191 114 279 291
Kenwood	026 066 145 192 182 005 280 374
Klh	331
Klipsch	042 043 081 687
Koss	216
Krell	072 376 384
Kyocera	007
Lexicon	120 235 236 237 357 360
Linn	124 377
Loewe	904 905 907 908 909
Luxman	139 052 165 115 004 009
LXI	056
Magnavox	086 164 152 208
Marantz	006 028 031 040 063 185 479 251 265 119 289

Mcintosh	238 286
Meridian	100 012 013
Mitsubish	242 243 204
Mondial	157 158 042 043 081 112
Musical Fidelity	647 648
Myryad	276 293
Nad	113 283 478 479
Naim	533 534 535
Nakamichi	040 244 245 172 183 287
NEC	176
Niles	403
Onkyo	017 046 108 080 209 275
Optimus	026
Outlaw	342
Panasonic	032 195 219 177 292 383
Parasound	129 130 132 261 294 295 333 334
Philips	249 250 251 063 119 805
Pioneer	014 044 069 168 116 035 078 198 480
Polkaudio	515
Primare	461 462 463 464 465
Proceed	144 268
RCA	010 048 117 156 067 288
Realistic	019 056 073 075 095
Rotel	074 083 085
Russound	379 391 392
Samsung	016 804
Sansui	040 048 110 119 065 228
Sanyo	047
Scott	019 091
Sharp	026 094 026 175
Sherwood	024 102 106 447
Sirius	555
Sony	018 247 248 166 101 184 218 271 369 372 380
SSI	068
Sugden	430
Sunfire	344 345 346
Systemline	759
Teac	005 019 049 040 212 217
Technics	122 176 193 219 178 177 200 257 262
Theta Digital	136
Toshiba	060 087 198 278
XM Satellite Radio	515
Yamaha	026 253 169 067 173 264 232 089 264 274 285 373 803 644
Zenith	143 210

CD

Adcom	062 042
Aiwa	089 170 187
Akai	202
Amc	231 232
Arcam	001 238 275
Audio Access	119 147
Audio Ease	165
Audio Technica	046
California Audio	147 008
Cambridge Audio	268
Carver	185 041 050 067 107 130 134 135 138 139 203 167
Classe	267
Creek	159
Denon	002 123
Emerson	042
Fisher	050 185 134 008
Genexxa	010
Goldstar	080
Harman Kardon	033 047 208
Hitachi	042 175
Inkel	130
Insignia	298
Integra	030 273
Jcpenney	141
Jensen	158
JVC	004 022 136 163 213 214 242 243
Kenwood	185 007 023 055 071 072 142 137 254
Krell	241 255
Kyocera	005
Linn	295
Loewe	256
Luxman	011 028 070 249 252
Magnavox	107
Marantz	041 051 077 107 209 246
Mcintosh	212 247
Memorex	010
Mission	107
Mitsubishi	179
Mondial	147
Musical Fidelity	258 284
Myryad	244 155
Nad	006 005 067 178 293
Nakamichi	217 218
NEC	062
Nikko	046
Nsm	107
Onkyo	030 038 039 168 169
Optimus	010 050 081
Panasonic	147 172 008 068 248
Parasound	233 240
Philips	041 107 246
Pioneer	010 020 174 175 176
Primare	266
Proceed	239
Proton	107
Quasar	147 008
RCA	017 042 150
Realistic	042 050 051 187
Rotel	107 161 178 250

SAE	107
Sansui	107 128 171 190 125
Sanyo	050
Sharp	026 031 051
Sherwood	051 096 112 115 119 166
Signature	033
Sony	048 081 097 126 133 177 226 164
Soundesign	251
Sumo	155
Sylvania	107
Symphonic	052
Tandy	010
Teac	051 052 233 079
Technics	147 172 184 008 068
Theta Digital	234 235
Toshiba	006 067 091 160 148
Victor	004 022
Wards	185 033
Yamaha	024 046 054 186 183 245

DVD

Aiwa	146
Akai	281
Alpine	098
Apex Digital	087 282 115
Arcam	001
Broksonic	130
Cambridge Audio	215 323 333
Cinevision	091
Coby	260
Cyberhome	271
Denon	138 080 173 358
Durabrand	091
DVD 2000	017
Emerson	091 143
ESA	143
Fisher	147
Funai	143
GE	027
Go Video	137 091 220 221
Goldstar	091
Harman Kardon	084 140
Hitachi	101
Initial	282
Insignia	143
Integra	142 338
JBC	084
JVC	012
Kenwood	151
Kiss	279
KLH	135
Krell	104
Lexicon	148
LG	091 057
Linn	306 309
Liteon	264
Loewe	359 360
Magnavox	001 096 143 282
Marantz	083 095
Meridian	153
Microsoft	027
Mintek	282
Mitsubishi	017
Myrrad	102 134
Nad	088 353
Nakamichi	103
Onkyo	076 141 142 338
Oppo	341
Optimus	107
Orion	130
Panasonic	042 138 144 150 285
Philips	083 095 166 344
Philips-Magnovox	141 001
Pioneer	023 092 099 107 108 131 304 354
Polaroid	233
Polkaudio	141 001
Primare	193 194
Proscan	027
RCA	027
Rotel	335 336
Samsung	056 165 170 137 159 275
Sansui	130
Sanyo	147
Sears	130
Sharp	094
Sherwood	245 246 247 248 249 250 345

Sony	033 118 145 126 191 286 242 243 343 340
Superscan	143
Sv2000	143
Sylvania	143
Symphonic	143
Tag McLaren	156
Tatung	102
Teac	107
Technics	042
Techwood	088
Thompson	027
Toshiba	130 141 164 188 273 356
Venturer	149
X-Box	027
Yamaha	042 089 166 138 197 334
Zenith	057 091

DVD-TV combo

Aiwa	146
Akai	281
Durabrand	143
Esa	143
Funai	143
Insignia	143
Magnavox	282
Mintek	282
Samsung	165
SV2000	143
Sylvania	143
Symphonic	143
Toshiba	130

DVD-TV-VCR combo

Emerson	143
Insignia	143
Magnavox	143
Panasonic	144
Superscan	143
Sylvania	143
Toshiba	164

DVD-VCR combo

Go Video	137
Panasonic	150
Philips	001 (VCR functions 067)
Samsung	137 159
Sansui	130
Sony	145 191
Toshiba	141
Zenith	091 (VCR functions 101)

DVD-Recorder

Cyberhome	271
Go Video	220 221
Kiss	279
Panasonic	138
Samsung	301
Sony	191
Toshiba	188

Blu-ray/HD-DVD

Denon	358
LG	091
Nad	353
Onkyo	338
Panasonic	285
Pioneer	304 354
Samsung	275
Sony	286
Toshiba	273 356
Yamaha	197

Satellite STB

Acoustic Solutions	002 060
Akura	002 020 026 099 100
Alba	002 016 020 023 027 032 044 058 061 070 118
Antiference	073
Argos	044
Asda	002 099
Astratec	011
Astro	024
Audioline	007
Aurex	002
Black Diamond	002
Boca	024
Bush	002 007 009 011 016 020 023 027 029 030 032 044 052 053 058 062 064 069 073 079 092 098 102 103 112
Comag	024
Crown	002
Currys	062
Curtis	062 099
CYRUS	129
Daewoo	011 109
Digifusion	009 011
Digihome	002 020 073
Digilogic	002 026
Digitalstream	093
Dion	066 089 120
Dreamax	119
Dual	020
Durabrand	002 020 055
Essentials	062
Evesham	020
EZ Box	101
Ferguson	001 012 013 020 026 062 072 073
Fetch TV	086
Finlux	073 100
Freecom	045
Fuba	017
Fusion	009 011
Globo	024
Goodmans	002 011 019 020 023 027 029 030 032 044 058 064 069 070 071 098 102 103
Grundig	001 002 003 004 027 030 044 058 059 064 069 070 074 075 084 098
Hirschmann	024
Hitachi	002 020 082
Humax	012 018 028 035 048 049 050 051 054 108 115 116 117
i-Can	094
Icecrypt	063 090 095
Inverto	021
Kabel Digital	042 057
Kabel Figital	048
Labgear	026 104
Linsar	002 020 065 073 079
Lodas	002

Logik	002 013 020 036 062 065 087 092
Logisat	024
Lowry	073 085
Luxor	020 073 079
Manhattan	070 076
Maplin	020
Matsui	002 011 061
Medion	024
Meo	031 081
Metronic	007 046 047 067 068 072 073 076 077 079
Mico	016
Morgans.S.L.	024
Murphy	100
Nichimen	023
Nikkai	085
Onn	002 020
Pace	057 078 125
Pacific	002
Palcom	017
Panasonic	006
Philex	062
Philips	007 014 031 033 034 080 114
Premiere	048 054 057 116
Proline	002 016 020 026 062
Sagecom	056 096
Sagem	008 015 056 105
Samsung	037 038 091 111
Scientific Atlanta	081
SEG	002
Setanta	007
Sharp	020 079 083 088
Sky	048 054 125
Sky-digital	127
Sky HD	130
Sky+	128
Skymaster	017
Sony	010 110
Strong	002
TDC	081
Technika	002 020 058 070 073 086 087
Technomate	039 040 041 126
Technosonic	007
Techwood	002 020 079 100
Telewest	025
Tevion	007 017 023 104
Thomson	003 005 042 043 079 113
Top Up TV	007
Topfield	090
Toshiba	002
Triax	024 083 088
TVOnics	013 036 121 122 123 124
TWF Digital	007
Virgin Media	013 025
Walker	020
Wharfedale	002 020 079
Winix	097
Xenius	073
Yamada	026
Zon	078

Satellite Radio

Brix	555
Delphi	515
Polkaudio	515
Sirius	555
Sony	380
XM Satellite Radio	515

TV

A.R.Systems	160 418
Adl	299
Admiral	058 137 204 245 246
Adyson	159 219
Aeg	031 109 123 249 263 282 286 319 407
Ag	282
Ahh Isions	131
Aiostay	144
Akai	027 036 074 097 103 104 106 108 132 140 155 156 242 243 249 250 251 275 279 280 287 407 409 410
Akita	085
Akura	064 074 086 108 171 174 407 410 429 430 431
Alba	060 064 069 074 108 127 172 175 202 249 250 264 307 407 409
Alien	264
Allstar	108 251
Altus	250
Amstrad	025 074 123 171 245 249 286 407 409
Anam	285
Andersson	123
Anitech	108 185 219 251 267 277 410
Ansonic	108
Antecno	064
Aoc	016
Arc En Ciel	173 179
Arcelik	085 086 296
Ardem	085 250
Arena	127 250
Argos	250
Aristona	109 111 119 122 230
Asa	087 102 105 234
Asberg	185 267
Asora	171 410
Astrosound	108
Asuka	149
Atlantic	089 197
Audiosonic	074 085 090 108 110 159 164 171 185 218 250 263 267 269
Aurora	170 171 219
Autovox	123 158 159 163 197 249 282
Awa	108
Awatron	171
Axxion	409
Baird	032 188
Bang & Olufsen	204 239
Basic Line	033 108 120 170 249 264 277
Baur	036 042 045 074 092 096 097 108 111 131 132 134 158 171 211 212 216 217 233 251 256 266 408 414
Baysonic	410

Prima	219
Prime	249
Primus	251
Pro 2	031 407
Profex	136 171 267
Profilo	031 074 108 294 407
Profitronic	108 185
Proline	109 120 128 189 205 229 249 269 270 285 286 407
Prosonic	418
Protech	074 108 219 249 264
Provision	066 108 109 120 282 418
Pye	108 109 251
Quadro	123 249 286 293
Quelle	261 257 255 251 245 237 234 232 229 221 219 218 217 216 213 212 211 205 204 197 195 185 171 169 168 167 165 159 158 156 144 142 141 140 136 131 119 118 116 112 111 108 105 102 101 100 097 096 092 090 088 087 086 074 072 060 059 043 042 040 036 027 025
Radiola	065 067 108 251 420
Radiomarelli	108 161 164
Radionette	181
Radiotone	074 085 108 171 249 294 407 410
Rank/Bush/Murphy	232
Recor	108 249
Rediffusion	132
Redstar	282 407
Reflex	108 249 264 293
Reoc	250
Revox	131
Rex	088 089 137 164 197 245 246 247
Rft	064 085 116 132 204
Rm 2000	108 249 264
Roadstar	063 069 090 108 117 144 249 250 251 263 264 280 286
Robotron	204
Rosita	171
Rowa	249 283
Royal	277 410
Royal Lux	282
Saba	074 147 148 161 173 179 193 195 249 270
Sagem	206 273
Saisho	025 060 069 070 136 159 205
Sakio	171 410
Salora	032 066 074 103 104 105 116 128 132 134 135 137 140 145 156 159 237 242 249 251 275 276 279

Sambers	161 185 267
Samsung	045 086 108 126 159 171 220 237 257 268 284 408 410
Sankyo	108
Sansui	108 249 264 410
Sany	193
Sanyo	032 033 051 052 074 086 087 108 123 159 189 218 221 249 286 407 414 420
Schaub Lorenz	074 108 116 117 132 141 147 148 156 171 242 249 250 264 275 277 296 410
Schneider	063 064 069 088 108 116 127 141 152 158 159 163 233 242 243 249 250 251 264 269 282 324 409
Schneider (F)	065 067 251
Seelver	069
Seg	064 108 115 123 144 159 165 171 185 219 249 264 267 269 286 293 410
Seitech	282 407
Seleco	088 089 109 110 137 195 197 226 229 245 246 247 249 251 407
Select	264
Sencor	117
Sentra	049 064 242
Serino	273
Set	074
Sharp	073 081 082 083 084 171 224 424 433
Shintom	108 249
Shintoshii	108
Shivaki	108 144 249 264
Siarem	148 161 185 204
Siemens	074 092 096 097 100 101 218 219 221 256 294
Siera	069
Silva	243 407
Silva Schneider	031 074 282 286 294 407
Silver	064 074 171 224 277 410
Sim2	226
Singer	069 108 164 185 204 251
Sinudyne	025 062 063 069 074 118 148 158 162 185 196 204 212 249 251 282 407
Sky	187 194 207
Slx	264 407
Smaragd	172
Smc	418
Solavox	242
Sonitron	159 407
Sonix	194
Sonoko	249
Sonolor	140 156
Sontec	108

Sony	072 211 212 213 214 215 216 217
Soundcolor	074 108 249 264 407
Spectra	170
Standard	108
Starlite	108 171 264
Starlux	171
Stars	251
Stern	088 089 137 197 229 245 246 247
Strato	410
Strong	115 123 286
Sunkai	273
Sunstar	074 108 171
Superior	286
Supertech	074 108 171 243 249
Suprema	273
Swisstec	187 194 207 309
Tadistar	108
Tandberg	173 246 254
Tashiko	159 218 224
Tatung	063 066 069 070 079 108 118 128 159 161 184 189 282 286 407
Taurus	282 418
Tcl	152
Tcm	127
Td Design	131 140
Tec	108 144 159 165 166 170 171 243 247 249 264
Techline	108 123 185 249 264 293
Technica	249 282 286 407
Technisat	108 118 248
Techwood	115 123 249
Tecnimagen	069 251 407
Tecnison	108 159 171 249
Tecsonic	249
Tekon	171 268
Teleavia	173 178 179
Telefunken	177 179 193 195 225 261 270
Teleopta	171
Telerent	131 233
Telestar	031 074 108 227 282 294 407
Teletech	108 165 171 249 264
Teleton	088 089 134 159 197 247
Televie	031 407
Telra	031 074 108 294 407
Tensai	064 108 110 120 127 144 149 159 171 191 249 264
Tenson	171
Tesla	069 074 090 108 109 116 127 144 150 160 204 229 249 250 263 264 273 282 407
Tevion	127 225 249 250 264 287 294 407 408
Tewa	409
Thomson	134 173 179 193 195 261 270
Thomson Ir2000	004 005 006

Thomson Rec 80	010 011 012
Thorn	026 028 032 033 036 043 045 049 052 065 067 072 075 078 079 087 097 102 105 106 107 108 110 116 120 128 132 135 141 145 156 159 160 161 168 169 170 177 179 188 189 195 198 199 200 201 211 213 216 224 232 242 244 251 270 411 414 415 416
Thorn-Ferguson	160 188 195 198 200
Tobo	171 410
Tokyo	268
Topline	249 264
Topvision	085
Toshiba	026 027 036 037 042 043 045 047 048 049 050 063 092 100 202 203 208 232 249 250 268 284 416
Tosumi	250
Towada	144 185
Trans-Continents	069
Trilux	120 264 292
Tristar	064 410
Triumph	025 219 234
TVE	249
TWF	320
Uher	089 108 131 149 185 197 233 249
Ultravox	108 148 164 185 204
Unimor	085 086
United	063 090 108 170 250 263 282 286
Universum	025 074 086 087 097 100 102 103 104 105 108 109 116 123 140 171 218 219 227 229 234 237 243 245 249 260 264 270 274 275 276 279 286 293
Univox	204
Vestel	108 115 121 123 243 249 264 286 293 303
Vestl	434
Videocom	425
Videocoin	410
Videosat	165
Videoseven	187 194
Videoton	144 145 178 193 249 410
Vision	108 149 249
Visionmagic	187
Vog	069
Voxson	137 204
Walker	286
Waltham	134 145 159 171 178
Watson	064 074 108 127 149 171 194 249 264 293 410
Watt Radio	148 158 185

Wegavox	243 249 264 282 408
Welltech	250
Weltblick	108 110
Weston	413
Wharfedale	313 418
White Westinghouse	108 110 149 260
Wiewpia	428
Wilson	249
Winson	250
Worten	110 120 229 273 407
Xenius	298
Xiron	303
Yamo	064
Yoko	064 108 136 144 159 164 170 171 274 410
Zanela	224
Zanussi	137 197